

COLOR CODED LABELS



ALPHABETICAL



NUMERICAL



SOLID

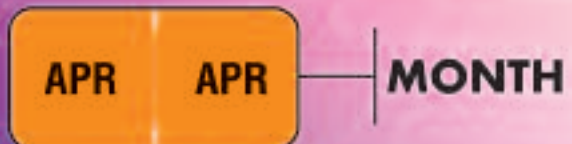

MONTH



YEARBANDS

Quality
you can
Stick
With

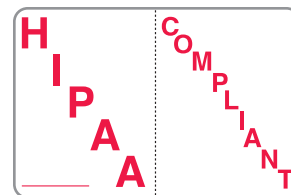

H A1010 Red/White
1-1/2" x 1" 250/BOX

AUTHORIZATIONS ON FILE

APPROVED BY

DATE

**Do Not Release
PATIENT RECORD**

QH MAP6880 White/Red
3-1/4" x 1-3/4" 250/BOX

**HIPAA
ACKNOWLEDGEMENTS
ON FILE**

B MAP687 Red/White
2-1/2" x 3/4" 300/BOX

**Signed
Acknowledgement
of Notice of Privacy
Practices on File**

I A1005 Blue/White
2" x 1" 500/BOX

CONFIDENTIAL

DL MAP 2000 Fl. Red
1-1/2" x 7/8" 250/BOX

The privacy and
security of your
personal health
information is
important to us!

DH MAP6860 Fl. Chartreuse
1-1/2" x 7/8" 250/BOX

**HIPAA
SIGNATURE
ON FILE**

F A1000 Fl. Orange
2-1/4" x 7/8" 420/BOX



V A1009 Fl. Orange
4" x 2-1/2" 100/BOX

**Patient
Record
Confidential**

SX MAP255 Green/White
2" x 2" 500/BOX

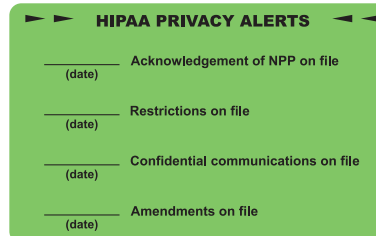

V A1008 Fl. Green
4" x 2-1/2" 100/BOX

**AUTHORIZATIONS
ON FILE**

F A1004 Fl. Red
2-1/4" x 7/8" 420/BOX

**CONFIDENTIAL
For Authorized
Personnel Only**

V MAP253 Red/White
4" x 2-1/2" 100/BOX

**CONFIDENTIAL
For Authorized
Personnel Only**

SX MAP254 Red/White
2" x 2" 500/BOX

**Patient Record
Confidential**

V MAP256 Green/White
4" x 2-1/2" 100/BOX

**PHI
RESTRICTIONS
ON FILE**

F A1001 Lt. Blue
2-1/4" x 7/8" 420/BOX

**CONFIDENTIAL
For Authorized Personnel Only**

M MAP251 Red/White 6-1/2" x 1" 100/BOX

**AUTHORIZATIONS
REVOKED**

F A1003 Fl. Pink
2-1/4" x 7/8" 420/BOX

**Patient Record
Confidential**

M MAP252 Green/White 6-1/2" x 1" 100/BOX

HIPAA

Bright, eye catching colors highlight your commitment to privacy and confidentiality to staff and patients. Pressure sensitive labels document your compliance efforts. All labels packaged in self-dispensing boxes.

*ACTUAL SIZE NOT SHOWN

Trademarks which appear in the catalog / price list are used to clarify brand names of materials used in the manufacturing of particular items, products supplied to us for resale, or products manufactured by Arden Label, Inc., to be compatible with other manufacturers' lines. AMES® Ames Color-File; BARKLEY® Barkley; International Filing Company; COL-R-Tab® Xertrex International, Inc.; CONTROL-O-Fax® Expressbill/Web/MD-Healthcon; DATAFILE® Tab Products Corp; File Doctor® File Doctor, Inc. Integrated Filing; GBS (VRE)® GBS Filing Systems; JETER® Jeter Systems Corp; Medical Arts Press® Staple, Inc; PMA® Positive Marketing Associates; POS® Professional Office Systems, Inc.; REYNOLDS & REYNOLDS® Reynolds & Reynolds Co.; SAFEGUARD® Safeguard Business Systems, Inc.; SMEAD® Smead Manufacturing Company; TAB® Hamilton Sorter, Inc.; TABBIES® Xertrex International Corp.. Arden Label, Inc. claims no rights of ownership to these trademarks.

ALPHABETIC



BRAM SERIES

BARKLEY FABKM MATCH
Laminated 500/Roll

- | | |
|-------------|-------------|
| BRAM-AA-B45 | BRAM-NN-B45 |
| BRAM-BB-B45 | BRAM-OO-B45 |
| BRAM-CC-B45 | BRAM-PP-B45 |
| BRAM-DD-B45 | BRAM-QQ-B45 |
| BRAM-EE-B45 | BRAM-RR-B45 |
| BRAM-FF-B45 | BRAM-SS-B45 |
| BRAM-GG-B45 | BRAM-TT-B45 |
| BRAM-HH-B45 | BRAM-UU-B45 |
| BRAM-II-B45 | BRAM-VV-B45 |
| BRAM-JJ-B45 | BRAM-WW-B45 |
| BRAM-KK-B45 | BRAM-XX-B45 |
| BRAM-LL-B45 | BRAM-YY-B45 |
| BRAM-MM-B45 | BRAM-ZZ-B45 |
| BRAM-MC-B45 | |



BRPK SERIES

BARKLEY FABKM PACKS
Laminated 225/Pack

- | | |
|---------|--------|
| BRPK-A | BRPK-N |
| BRPK-B | BRPK-O |
| BRPK-C | BRPK-P |
| BRPK-D | BRPK-Q |
| BRPK-E | BRPK-R |
| BRPK-F | BRPK-S |
| BRPK-G | BRPK-T |
| BRPK-H | BRPK-U |
| BRPK-I | BRPK-V |
| BRPK-J | BRPK-W |
| BRPK-K | BRPK-X |
| BRPK-L | BRPK-Y |
| BRPK-M | BRPK-Z |
| BRPK-MC | |

BRPK-RK
DESK REFILL PACK
2,034 ASSORTED
LABELS



BRPK-CS
27 PACKS OF 225
6,075 LABELS

BRPK-DSET
FILE BOX, INDEXES,
2,034 ASSORTED LABELS

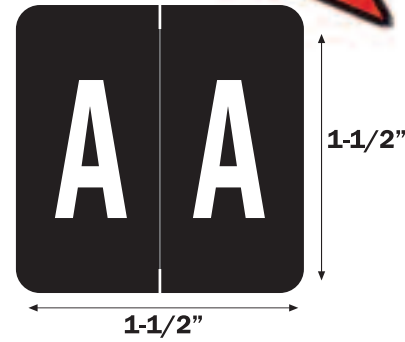

ADPK SERIES

BARKLEY FADBM PACKS
Laminated 228/Pack

- | | |
|---------|--------|
| ADPK-A | ADPK-N |
| ADPK-B | ADPK-O |
| ADPK-C | ADPK-P |
| ADPK-D | ADPK-Q |
| ADPK-E | ADPK-R |
| ADPK-F | ADPK-S |
| ADPK-G | ADPK-T |
| ADPK-H | ADPK-U |
| ADPK-I | ADPK-V |
| ADPK-J | ADPK-W |
| ADPK-K | ADPK-X |
| ADPK-L | ADPK-Y |
| ADPK-M | ADPK-Z |
| ADPK-MC | |

ADPK-RK
DESK REFILL PACK
2,028 ASSORTED
LABELS



ADPK-CS
27 PACKS OF 228
6,156 LABELS

ADPK-DSET
FILE BOX, INDEXES,
2,028 ASSORTED LABELS



SET# BRAM-AT-B45 (INCLUDES TRAY)



BXAM SERIES

BARKLEY FABEM MATCH
Laminated 500/Roll

- | | |
|-------------|-------------|
| BXAM-AA-B45 | BXAM-NN-B45 |
| BXAM-EE-B45 | BXAM-RR-B45 |
| BXAM-LL-B45 | BXAM-YY-B45 |



SET# BXAM-AT-B45



BAAM SERIES
BARKLEY FABAM MATCH
Laminated 500/Roll

- A A** BAAM-AA-S4 **N-N** BAAM-NN-S4
- B B** BAAM-BB-S4 **O-O** BAAM-OO-S4
- C C** BAAM-CC-S4 **P-P** BAAM-PP-S4
- D D** BAAM-DD-S4 **Q-Q** BAAM-QQ-S4
- E E** BAAM-EE-S4 **R-R** BAAM-RR-S4
- F F** BAAM-FF-S4 **S-S** BAAM-SS-S4
- G G** BAAM-GG-S4 **T-T** BAAM-TT-S4
- H H** BAAM-HH-S4 **U-U** BAAM-UU-S4
- I I** BAAM-II-S4 **V-V** BAAM-VV-S4
- J J** BAAM-JJ-S4 **W-W** BAAM-WW-S4
- K K** BAAM-KK-S4 **X-X** BAAM-XX-S4
- L L** BAAM-LL-S4 **Y-Y** BAAM-YY-S4
- M M** BAAM-MM-S4 **Z-Z** BAAM-ZZ-S4
- Mc Mc** BAAM-MC-S4



SET# BAAM-AT-S4 (INCLUDES TRAY)



BAPK SERIES
BARKLEY FABAM PACK
Laminated 225/Pack

- A A** BAPK-A **N-N** BAPK-N
- B B** BAPK-B **O-O** BAPK-O
- C C** BAPK-C **P-P** BAPK-P
- D D** BAPK-D **Q-Q** BAPK-Q
- E E** BAPK-E **R-R** BAPK-R
- F F** BAPK-F **S-S** BAPK-S
- G G** BAPK-G **T-T** BAPK-T
- H H** BAPK-H **U-U** BAPK-U
- I I** BAPK-I **V-V** BAPK-V
- J J** BAPK-J **W-W** BAPK-W
- K K** BAPK-K **X-X** BAPK-X
- L L** BAPK-L **Y-Y** BAPK-Y
- M M** BAPK-M **Z-Z** BAPK-Z
- Mc Mc** BAPK-MC

BAPK-RK
DESK REFILL PACK
2,145 ASSORTED LABELS

BAPK-CS
27 PACKS OF 225
6,075 LABELS



BAPK-DSET
FILE BOX, INDEXES,
2,145 ASSORTED LABELS

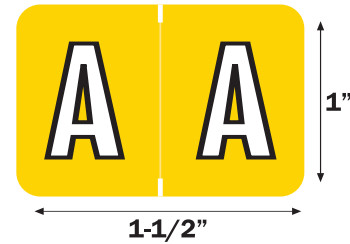

COAM SERIES
COLWELL JEWEL TONE MATCH
Laminated 500/Roll

- A A** COAM-AA-T4 **N-N** COAM-NN-T4
- B B** COAM-BB-T4 **O-O** COAM-OO-T4
- C C** COAM-CC-T4 **P-P** COAM-PP-T4
- D D** COAM-DD-T4 **Q-Q** COAM-QQ-T4
- E E** COAM-EE-T4 **R-R** COAM-RR-T4
- F F** COAM-FF-T4 **S-S** COAM-SS-T4
- G G** COAM-GG-T4 **T-T** COAM-TT-T4
- H H** COAM-HH-T4 **U-U** COAM-UU-T4
- I I** COAM-II-T4 **V-V** COAM-VV-T4
- J J** COAM-JJ-T4 **W-W** COAM-WW-T4
- K K** COAM-KK-T4 **X-X** COAM-XX-T4
- L L** COAM-LL-T4 **Y-Y** COAM-YY-T4
- M M** COAM-MM-T4 **Z-Z** COAM-ZZ-T4
- Mc Mc** COAM-MC-T4



SET# COAM-AT-T4 (INCLUDES TRAY)

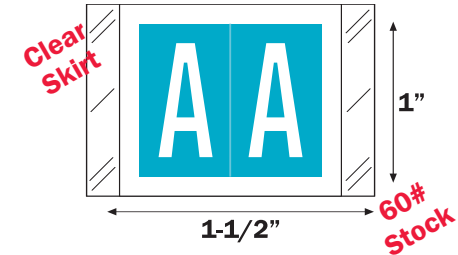

CTAM SERIES
BARKLEY FASTM MATCH
Laminated 500/Roll

- AA** CTAM-AA-V3 **NN** CTAM-NN-V3
- BB** CTAM-BB-V3 **OO** CTAM-OO-V3
- CC** CTAM-CC-V3 **PP** CTAM-PP-V3
- DD** CTAM-DD-V3 **QQ** CTAM-QQ-V3
- EE** CTAM-EE-V3 **RR** CTAM-RR-V3
- FF** CTAM-FF-V3 **SS** CTAM-SS-V3
- GG** CTAM-GG-V3 **TT** CTAM-TT-V3
- HH** CTAM-HH-V3 **UU** CTAM-UU-V3
- II** CTAM-II-V3 **VV** CTAM-VV-V3
- JJ** CTAM-JJ-V3 **WW** CTAM-WW-V3
- KK** CTAM-KK-V3 **XX** CTAM-XX-V3
- LL** CTAM-LL-V3 **YY** CTAM-YY-V3
- MM** CTAM-MM-V3 **ZZ** CTAM-ZZ-V3
- Mc Mc** CTAM-MC-V3



SET# CTAM-AT-V3 (INCLUDES TRAY)

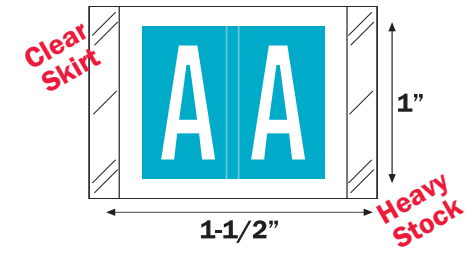

CRAM SERIES
TABBIES 12000 MATCH
Laminated 500/Roll

- AA** CRAM-AA-CT5 **NN** CRAM-NN-CT5
- BB** CRAM-BB-CT5 **OO** CRAM-OO-CT5
- CC** CRAM-CC-CT5 **PP** CRAM-PP-CT5
- DD** CRAM-DD-CT5 **QQ** CRAM-QQ-CT5
- EE** CRAM-EE-CT5 **RR** CRAM-RR-CT5
- FF** CRAM-FF-CT5 **SS** CRAM-SS-CT5
- GG** CRAM-GG-CT5 **TT** CRAM-TT-CT5
- HH** CRAM-HH-CT5 **UU** CRAM-UU-CT5
- II** CRAM-II-CT5 **VV** CRAM-VV-CT5
- JJ** CRAM-JJ-CT5 **WW** CRAM-WW-CT5
- KK** CRAM-KK-CT5 **XX** CRAM-XX-CT5
- LL** CRAM-LL-CT5 **YY** CRAM-YY-CT5
- MM** CRAM-MM-CT5 **ZZ** CRAM-ZZ-CT5
- Mc Mc** CRAM-MC-CT5



SET# CRAM-AT-CT5 (INCLUDES TRAY)

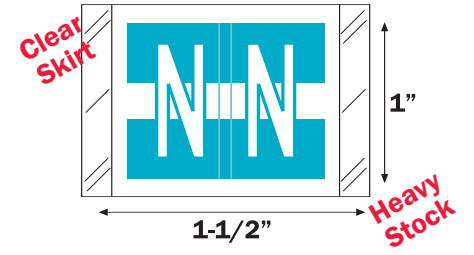

CXAM SERIES
TABBIES 12030 MATCH
Laminated 500/Roll

- AA** CXAM-AA-CT5 **NN** CXAM-NN-CT5
- BB** CXAM-BB-CT5 **OO** CXAM-OO-CT5
- CC** CXAM-CC-CT5 **PP** CXAM-PP-CT5
- DD** CXAM-DD-CT5 **QQ** CXAM-QQ-CT5
- EE** CXAM-EE-CT5 **RR** CXAM-RR-CT5
- FF** CXAM-FF-CT5 **SS** CXAM-SS-CT5
- GG** CXAM-GG-CT5 **TT** CXAM-TT-CT5
- HH** CXAM-HH-CT5 **UU** CXAM-UU-CT5
- II** CXAM-II-CT5 **VV** CXAM-VV-CT5
- JJ** CXAM-JJ-CT5 **WW** CXAM-WW-CT5
- KK** CXAM-KK-CT5 **XX** CXAM-XX-CT5
- LL** CXAM-LL-CT5 **YY** CXAM-YY-CT5
- MM** CXAM-MM-CT5 **ZZ** CXAM-ZZ-CT5
- Mc Mc** CXAM-MC-CT5



SET# CXAM-AT-CT5 (INCLUDES TRAY)

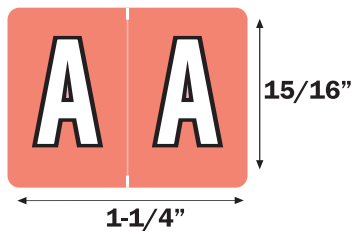

AL8720 SERIES
DATAFILE MATCH
 Laminated 500/Roll

- | | | | |
|--|--------------|--|--------------|
| | AL8720-AA-T3 | | AL8720-NN-T3 |
| | AL8720-BB-T3 | | AL8720-OO-T3 |
| | AL8720-CC-T3 | | AL8720-PP-T3 |
| | AL8720-DD-T3 | | AL8720-QQ-T3 |
| | AL8720-EE-T3 | | AL8720-RR-T3 |
| | AL8720-FF-T3 | | AL8720-SS-T3 |
| | AL8720-GG-T3 | | AL8720-TT-T3 |
| | AL8720-HH-T3 | | AL8720-UU-T3 |
| | AL8720-II-T3 | | AL8720-VV-T3 |
| | AL8720-JJ-T3 | | AL8720-WW-T3 |
| | AL8720-KK-T3 | | AL8720-XX-T3 |
| | AL8720-LL-T3 | | AL8720-YY-T3 |
| | AL8720-MM-T3 | | AL8720-ZZ-T3 |



SET# A8720-50-T3 (INCLUDES TRAY)

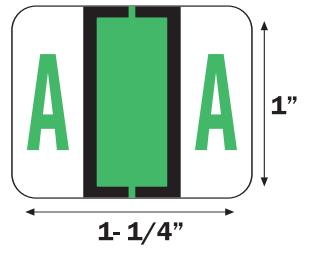

FDAV SERIES
FILE DOCTOR MATCH
 Vinyl 500/Roll

- * Fluorescent Ink Color
- | | | | |
|--|------------|--|------------|
| | FDAV-AA-T4 | | FDAV-NN-T4 |
| | FDAV-BB-T4 | | FDAV-OO-T4 |
| | FDAV-CC-T4 | | FDAV-PP-T4 |
| | FDAV-DD-T4 | | FDAV-QQ-T4 |
| | FDAV-EE-T4 | | FDAV-RR-T4 |
| | FDAV-FF-T4 | | FDAV-SS-T4 |
| | FDAV-GG-T4 | | FDAV-TT-T4 |
| | FDAV-HH-T4 | | FDAV-UU-T4 |
| | FDAV-II-T4 | | FDAV-VV-T4 |
| | FDAV-JJ-T4 | | FDAV-WW-T4 |
| | FDAV-KK-T4 | | FDAV-XX-T4 |
| | FDAV-LL-T4 | | FDAV-YY-T4 |
| | FDAV-MM-T4 | | FDAV-ZZ-T4 |
| | FDAV-MC-T4 | | |

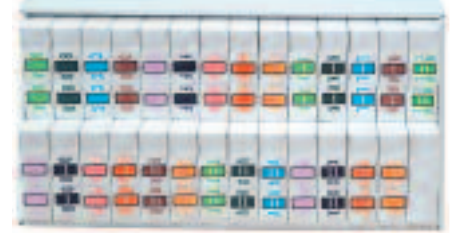

SET# FDAV-AT-T4 (INCLUDES TRAY)

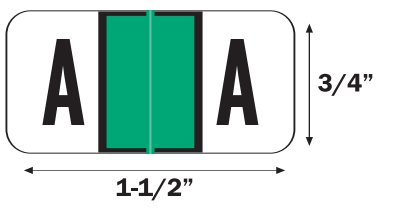

JSAM SERIES
JETER 2900 MATCH
 Laminated 500/Roll

- | | | | |
|--|------------|--|------------|
| | JSAM-AA-T4 | | JSAM-NN-T4 |
| | JSAM-BB-T4 | | JSAM-OO-T4 |
| | JSAM-CC-T4 | | JSAM-PP-T4 |
| | JSAM-DD-T4 | | JSAM-QQ-T4 |
| | JSAM-EE-T4 | | JSAM-RR-T4 |
| | JSAM-FF-T4 | | JSAM-SS-T4 |
| | JSAM-GG-T4 | | JSAM-TT-T4 |
| | JSAM-HH-T4 | | JSAM-UU-T4 |
| | JSAM-II-T4 | | JSAM-VV-T4 |
| | JSAM-JJ-T4 | | JSAM-WW-T4 |
| | JSAM-KK-T4 | | JSAM-XX-T4 |
| | JSAM-LL-T4 | | JSAM-YY-T4 |
| | JSAM-MM-T4 | | JSAM-ZZ-T4 |
| | JSAM-MC-T4 | | |



SET# JSAM-AT-T4 (INCLUDES TRAY)

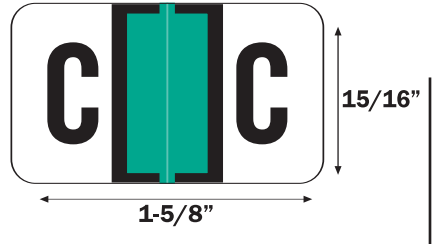

JAAM SERIES
JETER 0200 MATCH
 Laminated 500/Roll

- | | | | |
|--|------------|--|------------|
| | JAAM-AA-T4 | | JAAM-NN-T4 |
| | JAAM-BB-T4 | | JAAM-OO-T4 |
| | JAAM-CC-T4 | | JAAM-PP-T4 |
| | JAAM-DD-T4 | | JAAM-QQ-T4 |
| | JAAM-EE-T4 | | JAAM-RR-T4 |
| | JAAM-FF-T4 | | JAAM-SS-T4 |
| | JAAM-GG-T4 | | JAAM-TT-T4 |
| | JAAM-HH-T4 | | JAAM-UU-T4 |
| | JAAM-II-T4 | | JAAM-VV-T4 |
| | JAAM-JJ-T4 | | JAAM-WW-T4 |
| | JAAM-KK-T4 | | JAAM-XX-T4 |
| | JAAM-LL-T4 | | JAAM-YY-T4 |
| | JAAM-MM-T4 | | JAAM-ZZ-T4 |
| | JAAM-MC-T4 | | |



SET# JAAM-AT-T4 (INCLUDES TRAY)

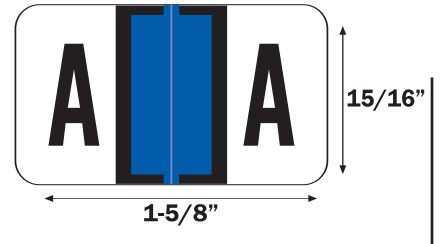

JEAM SERIES
JETER 2800 MATCH
 Laminated 500/Roll

- | | | | |
|--|------------|--|------------|
| | JEAM-AA-T4 | | JEAM-NN-T4 |
| | JEAM-BB-T4 | | JEAM-OO-T4 |
| | JEAM-CC-T4 | | JEAM-PP-T4 |
| | JEAM-DD-T4 | | JEAM-QQ-T4 |
| | JEAM-EE-T4 | | JEAM-RR-T4 |
| | JEAM-FF-T4 | | JEAM-SS-T4 |
| | JEAM-GG-T4 | | JEAM-TT-T4 |
| | JEAM-HH-T4 | | JEAM-UU-T4 |
| | JEAM-II-T4 | | JEAM-VV-T4 |
| | JEAM-JJ-T4 | | JEAM-WW-T4 |
| | JEAM-KK-T4 | | JEAM-XX-T4 |
| | JEAM-LL-T4 | | JEAM-YY-T4 |
| | JEAM-MM-T4 | | JEAM-ZZ-T4 |
| | JEAM-MC-T4 | | |



SET# JEAM-AT-T4 (INCLUDES TRAY)

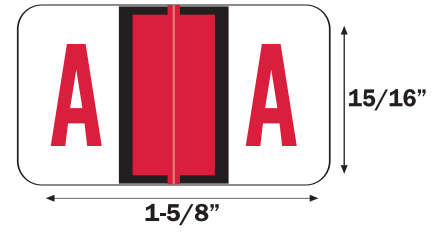

JRAM SERIES
JETER/TAB 5100 MATCH
 Laminated 500/Roll

- | | | | |
|--|------------|--|------------|
| | JRAM-AA-T4 | | JRAM-NN-T4 |
| | JRAM-BB-T4 | | JRAM-OO-T4 |
| | JRAM-CC-T4 | | JRAM-PP-T4 |
| | JRAM-DD-T4 | | JRAM-QQ-T4 |
| | JRAM-EE-T4 | | JRAM-RR-T4 |
| | JRAM-FF-T4 | | JRAM-SS-T4 |
| | JRAM-GG-T4 | | JRAM-TT-T4 |
| | JRAM-HH-T4 | | JRAM-UU-T4 |
| | JRAM-II-T4 | | JRAM-VV-T4 |
| | JRAM-JJ-T4 | | JRAM-WW-T4 |
| | JRAM-KK-T4 | | JRAM-XX-T4 |
| | JRAM-LL-T4 | | JRAM-YY-T4 |
| | JRAM-MM-T4 | | JRAM-ZZ-T4 |
| | JRAM-MC-T4 | | |

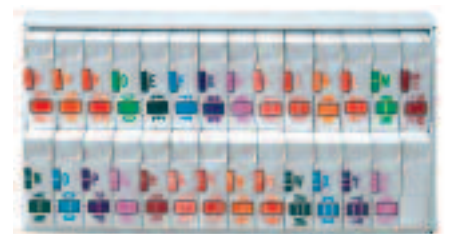

SET# JRAM-AT-T4 (INCLUDES TRAY)

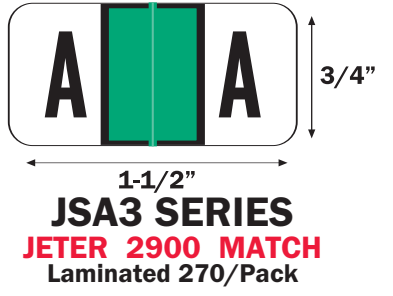

JSA3 SERIES
JETER 2900 MATCH
 Laminated 270/Pack

- | | | | | | | | |
|--|--------|--|---------|--|--------|--|--------|
| | JSA3-A | | JSA3-H | | JSA3-N | | JSA3-U |
| | JSA3-B | | JSA3-I | | JSA3-O | | JSA3-V |
| | JSA3-C | | JSA3-J | | JSA3-P | | JSA3-W |
| | JSA3-D | | JSA3-K | | JSA3-Q | | JSA3-X |
| | JSA3-E | | JSA3-L | | JSA3-R | | JSA3-Y |
| | JSA3-F | | JSA3-M | | JSA3-S | | JSA3-Z |
| | JSA3-G | | JSA3-MC | | JSA3-T | | |

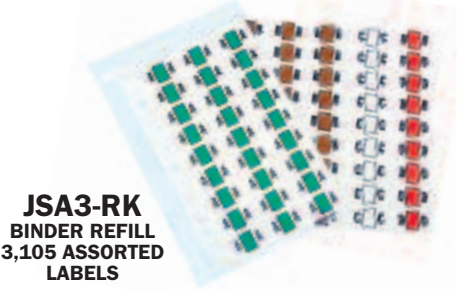

JSA3-RK
 BINDER REFILL
 3,105 ASSORTED
 LABELS



SET# JXAM-AT-T4

JXAM SERIES
JETER 5190 MATCH
 Laminated 500/Roll

- | | | | |
|--|------------|--|------------|
| | JXAM-FF-T4 | | JXAM-OO-T4 |
|--|------------|--|------------|

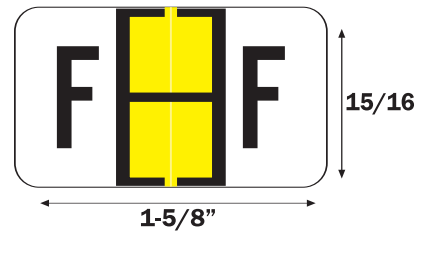

1-5/8"

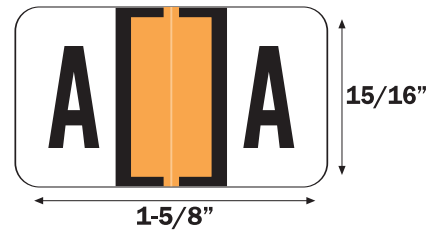

JTAM SERIES
JETER 7200 MATCH
 Laminated 500/Roll

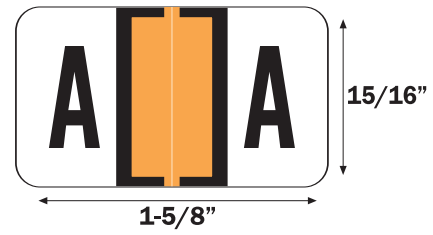

JTPK SERIES
JETER 7100 MATCH
 Laminated 225/Pack

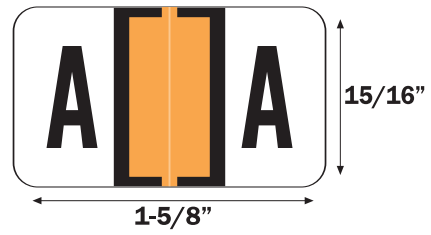

JT3R SERIES
JETER 5800 MATCH
 Laminated 240/Pack

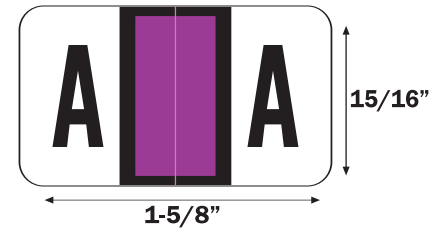

PP3R SERIES
POS 2000 MATCH
 Laminated 240/Pack

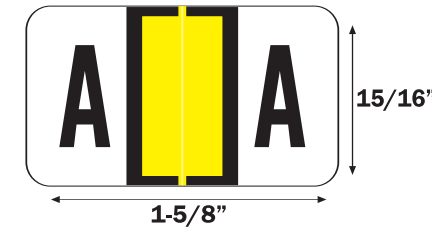

POAM SERIES
POS 3400 MATCH
 Laminated 500/Roll

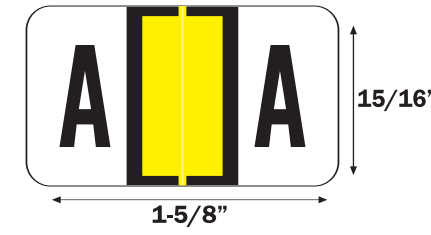

P03R SERIES
POS 3400 MATCH
 Laminated 240/Pack

- * JTAM-AA-T4 * JTAM-NN-T4
- JTAM-BB-T4 JTAM-OO-T4
- JTAM-CC-T4 JTAM-PP-T4
- JTAM-DD-T4 JTAM-QQ-T4
- JTAM-EE-T4 JTAM-RR-T4
- JTAM-FF-T4 JTAM-SS-T4
- JTAM-GG-T4 JTAM-TT-T4
- JTAM-HH-T4 JTAM-UU-T4
- JTAM-II-T4 JTAM-VV-T4
- JTAM-JJ-T4 JTAM-WW-T4
- JTAM-KK-T4 JTAM-XX-T4
- JTAM-LL-T4 JTAM-YY-T4
- JTAM-MM-T4 JTAM-ZZ-T4
- JTAM-MC-T4

- * JTPK-A * JTPK-N
- JTPK-B JTPK-O
- JTPK-C JTPK-P
- JTPK-D JTPK-Q
- JTPK-E JTPK-R
- JTPK-F JTPK-S
- JTPK-G JTPK-T
- JTPK-H JTPK-U
- JTPK-I JTPK-V
- JTPK-J JTPK-W
- JTPK-K JTPK-X
- JTPK-L JTPK-Y
- JTPK-M JTPK-Z
- JTPK-MC

- * JT3R-A * JT3R-N
- JT3R-B JT3R-O
- JT3R-C JT3R-P
- JT3R-D JT3R-Q
- JT3R-E JT3R-R
- JT3R-F JT3R-S
- JT3R-G JT3R-T
- JT3R-H JT3R-U
- JT3R-I JT3R-V
- JT3R-J JT3R-W
- JT3R-K JT3R-X
- JT3R-L JT3R-Y
- JT3R-M JT3R-Z
- JT3R-MC

- PP3R-A PP3R-N
- PP3R-B PP3R-O
- PP3R-C PP3R-P
- PP3R-D PP3R-Q
- PP3R-E PP3R-R
- PP3R-F PP3R-S
- PP3R-G PP3R-T
- PP3R-H PP3R-U
- PP3R-I PP3R-V
- PP3R-J PP3R-W
- PP3R-K PP3R-X
- PP3R-L PP3R-Y
- PP3R-M PP3R-Z
- PP3R-MC

- POAM-AA-T4 POAM-NN-T4
- POAM-BB-T4 POAM-OO-T4
- POAM-CC-T4 POAM-PP-T4
- POAM-DD-T4 POAM-QQ-T4
- POAM-EE-T4 POAM-RR-T4
- POAM-FF-T4 POAM-SS-T4
- POAM-GG-T4 POAM-TT-T4
- POAM-HH-T4 POAM-UU-T4
- POAM-II-T4 POAM-VV-T4
- POAM-JJ-T4 POAM-WW-T4
- POAM-KK-T4 POAM-XX-T4
- POAM-LL-T4 POAM-YY-T4
- POAM-MM-T4 POAM-ZZ-T4
- POAM-MC-T4

- P03R-A P03R-N
- P03R-B P03R-O
- P03R-C P03R-P
- P03R-D P03R-Q
- P03R-E P03R-R
- P03R-F P03R-S
- P03R-G P03R-T
- P03R-H P03R-U
- P03R-I P03R-V
- P03R-J P03R-W
- P03R-K P03R-X
- P03R-L P03R-Y
- P03R-M P03R-Z
- P03R-MC



SET# JTAM-AT-T4 (INCLUDES TRAY)

JTPK-RK
 DESK REFILL PACK
 2,898 ASSORTED LABELS

JTPK-CS
 27 PACKS OF 225
 6,075 LABELS

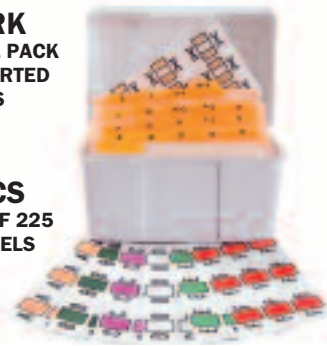

JTPK-DSET
 FILE BOX, INDEXES,
 2,898 ASSORTED LABELS

JT3R-RK
 BINDER REFILL
 3,120 ASSORTED LABELS

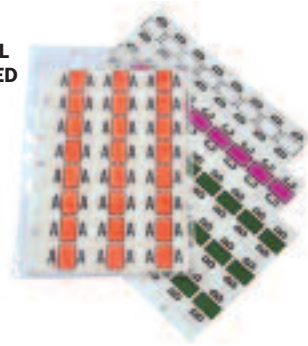

JT3R-CS
 27 PACKS OF 240
 6,480 LABELS

PP3R-RK
 BINDER REFILL
 3,120 ASSORTED LABELS

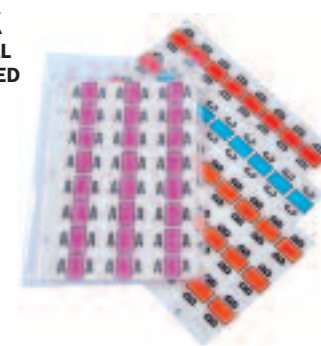

PP3R-CS
 27 PACKS OF 240
 6,480 LABELS

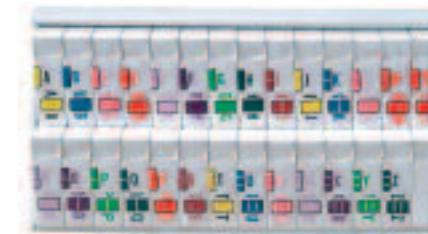

SET# POAM-AT-T4 (INCLUDES TRAY)

P03R-RK
 BINDER REFILL
 3,120 ASSORTED LABELS

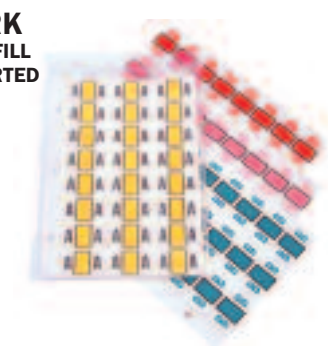

P03R-CS
 27 PACKS OF 240
 6,480 LABELS

* Fluorescent Ink Color

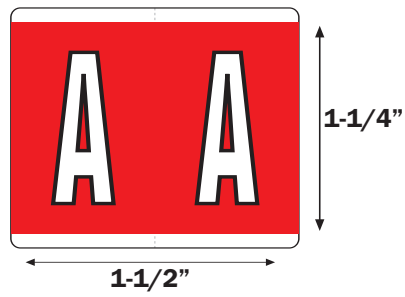

KXAM SERIES KARDEX PSF-139 ALPHA MATCH Laminated 500/Roll

- | | | | |
|--|------------|--|------------|
| | KXAM-AA-V3 | | KXAM-NN-V3 |
| | KXAM-BB-V3 | | KXAM-OO-V3 |
| | KXAM-CC-V3 | | KXAM-PP-V3 |
| | KXAM-DD-V3 | | KXAM-QQ-V3 |
| | KXAM-EE-V3 | | KXAM-RR-V3 |
| | KXAM-FF-V3 | | KXAM-SS-V3 |
| | KXAM-GG-V3 | | KXAM-TT-V3 |
| | KXAM-HH-V3 | | KXAM-UU-V3 |
| | KXAM-II-V3 | | KXAM-VV-V3 |
| | KXAM-JJ-V3 | | KXAM-WW-V3 |
| | KXAM-KK-V3 | | KXAM-XX-V3 |
| | KXAM-LL-V3 | | KXAM-YY-V3 |
| | KXAM-MM-V3 | | KXAM-ZZ-V3 |



SET# KXAM-AT-V3 (INCLUDES TRAY)

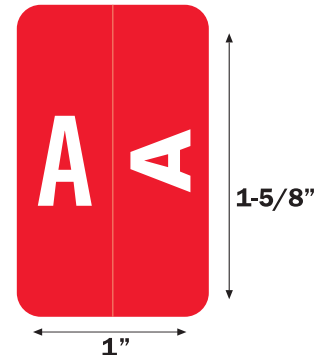

SMAM SERIES SMEAD ALPHA-Z ACC MATCH Laminated 250/Roll

- | | | | |
|--|------------|--|------------|
| | SMAM-AA-T4 | | SMAM-NN-T4 |
| | SMAM-BB-T4 | | SMAM-OO-T4 |
| | SMAM-CC-T4 | | SMAM-PP-T4 |
| | SMAM-DD-T4 | | SMAM-QQ-T4 |
| | SMAM-EE-T4 | | SMAM-RR-T4 |
| | SMAM-FF-T4 | | SMAM-SS-T4 |
| | SMAM-GG-T4 | | SMAM-TT-T4 |
| | SMAM-HH-T4 | | SMAM-UU-T4 |
| | SMAM-II-T4 | | SMAM-VV-T4 |
| | SMAM-JJ-T4 | | SMAM-WW-T4 |
| | SMAM-KK-T4 | | SMAM-XX-T4 |
| | SMAM-LL-T4 | | SMAM-YY-T4 |
| | SMAM-MM-T4 | | SMAM-ZZ-T4 |



SET# SMAM-AT-T4 (INCLUDES TRAY)

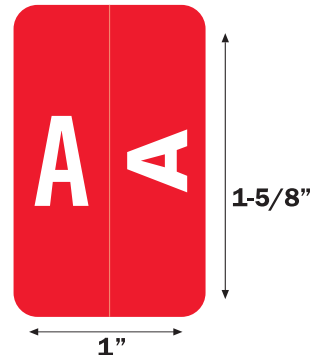

SMPK SHEETS SMEAD ALPHA-Z ACCS MATCH Laminated 100/Pack

- | | | | |
|--|---------|--|--------|
| | SMPK-A | | SMPK-N |
| | SMPK-B | | SMPK-O |
| | SMPK-C | | SMPK-P |
| | SMPK-D | | SMPK-Q |
| | SMPK-E | | SMPK-R |
| | SMPK-F | | SMPK-S |
| | SMPK-G | | SMPK-T |
| | SMPK-H | | SMPK-U |
| | SMPK-I | | SMPK-V |
| | SMPK-J | | SMPK-W |
| | SMPK-K | | SMPK-X |
| | SMPK-L | | SMPK-Y |
| | SMPK-MM | | SMPK-Z |

SMPK-RK
DESK REFILL PACK
2,200 ASSORTED LABELS

SMPK-CS
26 PACKS OF 100
2,600 LABELS



SMPK-DSET
FILE BOX, INDEXES,
2,200 ASSORTED LABELS

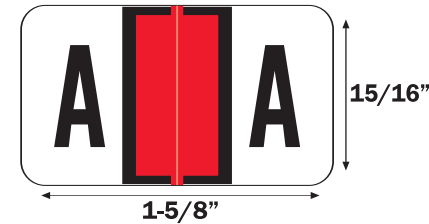

SGAM SERIES SAFEGUARD 514 MATCH Laminated 500/Roll

- | | | | |
|--|------------|--|------------|
| | SGAM-AA-T4 | | SGAM-NN-T4 |
| | SGAM-BB-T4 | | SGAM-OO-T4 |
| | SGAM-CC-T4 | | SGAM-PP-T4 |
| | SGAM-DD-T4 | | SGAM-QQ-T4 |
| | SGAM-EE-T4 | | SGAM-RR-T4 |
| | SGAM-FF-T4 | | SGAM-SS-T4 |
| | SGAM-GG-T4 | | SGAM-TT-T4 |
| | SGAM-HH-T4 | | SGAM-UU-T4 |
| | SGAM-II-T4 | | SGAM-VV-T4 |
| | SGAM-JJ-T4 | | SGAM-WW-T4 |
| | SGAM-KK-T4 | | SGAM-XX-T4 |
| | SGAM-LL-T4 | | SGAM-YY-T4 |
| | SGAM-MM-T4 | | SGAM-ZZ-T4 |
| | SGAM-MC-T4 | | |



SET# SGAM-AT-T4 (INCLUDES TRAY)

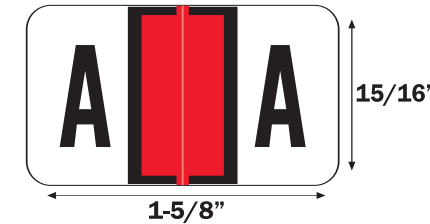

SG3R SERIES SAFEGUARD 511 MATCH Laminated 240/Pack

- | | | | |
|--|---------|--|--------|
| | SG3R-A | | SG3R-N |
| | SG3R-B | | SG3R-O |
| | SG3R-C | | SG3R-P |
| | SG3R-D | | SG3R-Q |
| | SG3R-E | | SG3R-R |
| | SG3R-F | | SG3R-S |
| | SG3R-G | | SG3R-T |
| | SG3R-H | | SG3R-U |
| | SG3R-I | | SG3R-V |
| | SG3R-J | | SG3R-W |
| | SG3R-K | | SG3R-X |
| | SG3R-L | | SG3R-Y |
| | SG3R-M | | SG3R-Z |
| | SG3R-MC | | |

SG3R-RK
BINDER REFILL
3,120 ASSORTED LABELS

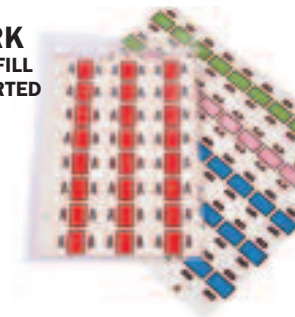

SG3R-CS
27 PACKS OF 240
6,480 LABELS

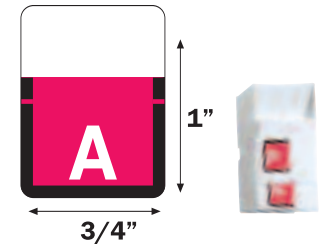

A1307 SERIES TAB PRODUCTS 1307 MATCH New Tab Colors Vinyl 500/Roll

- | | | | |
|--|-------------|--|-------------|
| | A1307-AA-T3 | | A1307-NN-T3 |
| | A1307-BB-T3 | | A1307-OO-T3 |
| | A1307-CC-T3 | | A1307-PP-T3 |
| | A1307-DD-T3 | | A1307-QQ-T3 |
| | A1307-EE-T3 | | A1307-RR-T3 |
| | A1307-FF-T3 | | A1307-SS-T3 |
| | A1307-GG-T3 | | A1307-TT-T3 |
| | A1307-HH-T3 | | A1307-UU-T3 |
| | A1307-II-T3 | | A1307-VV-T3 |
| | A1307-JJ-T3 | | A1307-WW-T3 |
| | A1307-KK-T3 | | A1307-XX-T3 |
| | A1307-LL-T3 | | A1307-YY-T3 |
| | A1307-MM-T3 | | A1307-ZZ-T3 |



SET# A1307-50-T3 (INCLUDES TRAY)

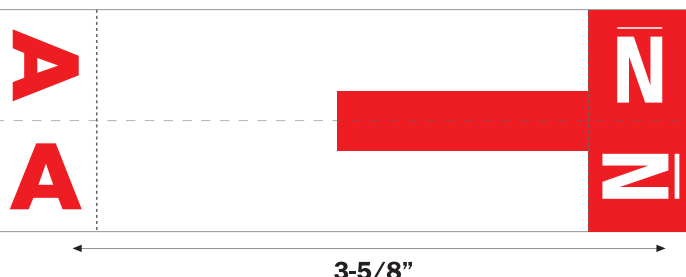

SNCC SHEETS SMEAD NCC MATCH Laminated 100/Pack

- | | | | |
|--|---------|--|---------|
| | SNCC-AN | | SNCC-HU |
| | SNCC-BO | | SNCC-IV |
| | SNCC-CP | | SNCC-JW |
| | SNCC-DQ | | SNCC-KX |
| | SNCC-ER | | SNCC-LY |
| | SNCC-FS | | SNCC-MZ |
| | SNCC-GT | | |

SNCC-CS
13 PACKS OF 100
1,300 LABELS

SNCC-RK
DESK REFILL PACK
1,500 ASSORTED LABELS

SNCC-DSET
FILE BOX, INDEXES,
1,500 ASSORTED LABELS



* Fluorescent Ink Color

* Fluorescent Ink Color

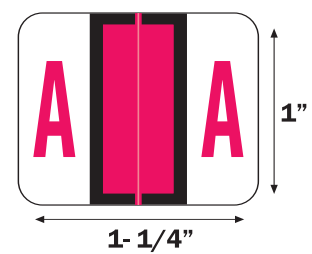

TPAM SERIES
SMEAD BCCR MATCH
Laminated 500/Roll

- | | | | |
|---|------------|---|-------------|
| | TPAM-AA-T4 | | TPAM-NN-T4 |
| * | TPAM-BB-T4 | | TPAM-OO-T4 |
| | TPAM-CC-T4 | | TPAM-PP-T4 |
| * | TPAM-DD-T4 | | TPAM-QQ-T4 |
| | TPAM-EE-T4 | | TPAM-RR-T4 |
| | TPAM-FF-T4 | | TPAM-SS-T4 |
| | TPAM-GG-T4 | | TPAM-TT-T4 |
| | TPAM-HH-T4 | * | TPAM-UU-T4 |
| | TPAM-II-T4 | | TPAM-VV-T4 |
| | TPAM-JJ-T4 | | TPAM-WW-T4 |
| * | TPAM-KK-T4 | | TPAM-XX-T4 |
| | TPAM-LL-T4 | | TPAM-YY-T4 |
| * | TPAM-MM-T4 | | TPAM-ZZ-T4 |
| | TPAM-MC-T4 | * | TPAM-MCG-T4 |



SET# TPAM-AT-T4 (INCLUDES TRAY)
Smead Brown "Mc"

SET# TPAM-ATG-T4 (INCLUDES TRAY)
Tab Fl. Green "Mc"

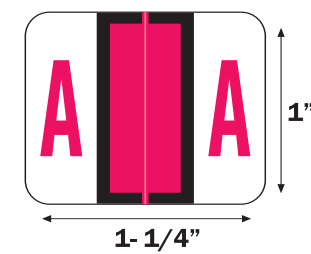

TPPK SERIES
SMEAD BCCS MATCH
Laminated 120/Pack

- | | | | |
|---|---------|---|--------|
| | TPPK-A | | TPPK-N |
| * | TPPK-B | | TPPK-O |
| | TPPK-C | | TPPK-P |
| * | TPPK-D | | TPPK-Q |
| | TPPK-E | | TPPK-R |
| | TPPK-F | | TPPK-S |
| | TPPK-G | | TPPK-T |
| | TPPK-H | * | TPPK-U |
| | TPPK-I | | TPPK-V |
| | TPPK-J | | TPPK-W |
| * | TPPK-K | | TPPK-X |
| | TPPK-L | | TPPK-Y |
| * | TPPK-M | | TPPK-Z |
| | TPPK-MC | | |

TPPK-RK
DESK REFILL PACK
2,484 ASSORTED LABELS

TPPK-CS
27 PACKS OF 120
3,240 LABELS

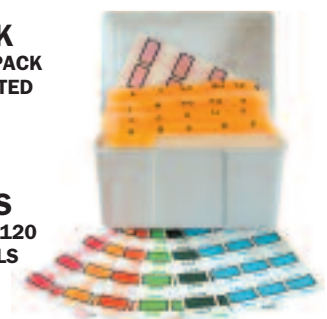

TPPK-DSET
FILE BOX, INDEXES,
2,484 ASSORTED LABELS

*Fluorescent Ink Color

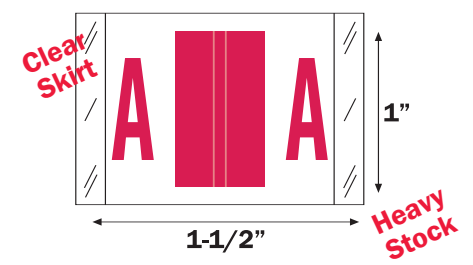

TTAM SERIES
TABBIES 14100 MATCH
Laminated 500/Roll

- | | | | |
|---|-------------|---|-------------|
| | TTAM-AA-CT5 | | TTAM-NN-CT5 |
| * | TTAM-BB-CT5 | | TTAM-OO-CT5 |
| | TTAM-CC-CT5 | | TTAM-PP-CT5 |
| * | TTAM-DD-CT5 | | TTAM-QQ-CT5 |
| | TTAM-EE-CT5 | | TTAM-RR-CT5 |
| | TTAM-FF-CT5 | | TTAM-SS-CT5 |
| | TTAM-GG-CT5 | | TTAM-TT-CT5 |
| | TTAM-HH-CT5 | * | TTAM-UU-CT5 |
| | TTAM-II-CT5 | | TTAM-VV-CT5 |
| | TTAM-JJ-CT5 | | TTAM-WW-CT5 |
| * | TTAM-KK-CT5 | | TTAM-XX-CT5 |
| | TTAM-LL-CT5 | | TTAM-YY-CT5 |
| * | TTAM-MM-CT5 | | TTAM-ZZ-CT5 |
| * | TTAM-MC-CT5 | | |



SET# TTAM-AT-CT5 (INCLUDES TRAY)

*Fluorescent Ink Color

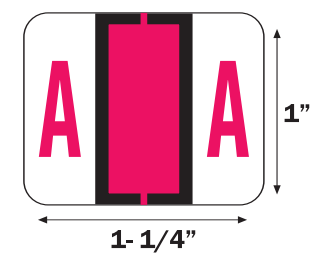

A1283 SERIES
TAB PRODUCTS 1283 MATCH
New Tab Colors Vinyl 500/Roll

- | | | | |
|--|-------------|--|-------------|
| | A1283-AA-T3 | | A1283-NN-T3 |
| | A1283-BB-T3 | | A1283-OO-T3 |
| | A1283-CC-T3 | | A1283-PP-T3 |
| | A1283-DD-T3 | | A1283-QQ-T3 |
| | A1283-EE-T3 | | A1283-RR-T3 |
| | A1283-FF-T3 | | A1283-SS-T3 |
| | A1283-GG-T3 | | A1283-TT-T3 |
| | A1283-HH-T3 | | A1283-UU-T3 |
| | A1283-II-T3 | | A1283-VV-T3 |
| | A1283-JJ-T3 | | A1283-WW-T3 |
| | A1283-KK-T3 | | A1283-XX-T3 |
| | A1283-LL-T3 | | A1283-YY-T3 |
| | A1283-MM-T3 | | A1283-ZZ-T3 |
| | A1283-MC-T3 | | |



SET# A1283-50-T3 (INCLUDES TRAY)
MC NOT INCLUDED

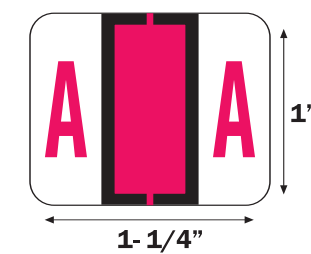

A1286 SHEETS
TAB PRODUCTS 1286 MATCH
New Tab Colors 50 Labels /Sheet

- | | | | |
|--|-------------|--|------------|
| | A1286-A-SH | | A1286-N-SH |
| | A1286-B-SH | | A1286-O-SH |
| | A1286-C-SH | | A1286-P-SH |
| | A1286-D-SH | | A1286-Q-SH |
| | A1286-E-SH | | A1286-R-SH |
| | A1286-F-SH | | A1286-S-SH |
| | A1286-G-SH | | A1286-T-SH |
| | A1286-H-SH | | A1286-U-SH |
| | A1286-I-SH | | A1286-V-SH |
| | A1286-J-SH | | A1286-W-SH |
| | A1286-K-SH | | A1286-X-SH |
| | A1286-L-SH | | A1286-Y-SH |
| | A1286-M-SH | | A1286-Z-SH |
| | A1286-MC-SH | | |

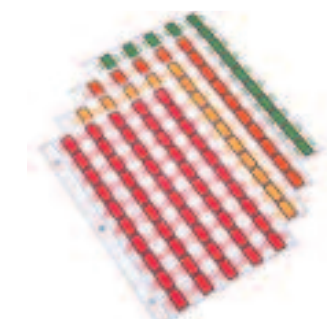

A1286-00
3,100 ASSORTED LABELS

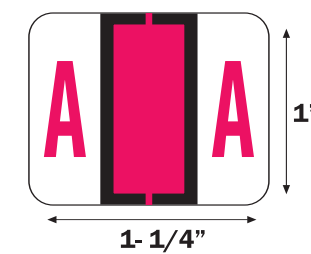

TPAV SERIES
TAB PRODUCTS MATCH
Fluorescent Colors Vinyl 500/Roll

- | | | | |
|---|------------|---|------------|
| | TPAV-AA-T4 | | TPAV-NN-T4 |
| * | TPAV-BB-T4 | | TPAV-OO-T4 |
| | TPAV-CC-T4 | | TPAV-PP-T4 |
| * | TPAV-DD-T4 | | TPAV-QQ-T4 |
| | TPAV-EE-T4 | | TPAV-RR-T4 |
| | TPAV-FF-T4 | | TPAV-SS-T4 |
| | TPAV-GG-T4 | | TPAV-TT-T4 |
| | TPAV-HH-T4 | * | TPAV-UU-T4 |
| | TPAV-II-T4 | | TPAV-VV-T4 |
| | TPAV-JJ-T4 | | TPAV-WW-T4 |
| * | TPAV-KK-T4 | | TPAV-XX-T4 |
| | TPAV-LL-T4 | | TPAV-YY-T4 |
| * | TPAV-MM-T4 | | TPAV-ZZ-T4 |
| * | TPAV-MC-T4 | | |



SET# TPAV-AT-T4 (INCLUDES TRAY)

*Fluorescent Ink Color

12 ALPHABETIC

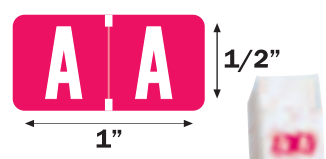

A1278 SERIES

TAB PRODUCTS 1278 MATCH
New Tab Colors Vinyl 500/Roll

- A A** A1278-AA-T3 **N N** A1278-NN-T3
- B B** A1278-BB-T3 **O O** A1278-OO-T3
- C C** A1278-CC-T3 **P P** A1278-PP-T3
- D D** A1278-DD-T3 **Q Q** A1278-QQ-T3
- E E** A1278-EE-T3 **R R** A1278-RR-T3
- F F** A1278-FF-T3 **S S** A1278-SS-T3
- G G** A1278-GG-T3 **T T** A1278-TT-T3
- H H** A1278-HH-T3 **U U** A1278-UU-T3
- I I** A1278-II-T3 **V V** A1278-VV-T3
- J J** A1278-JJ-T3 **W W** A1278-WW-T3
- K K** A1278-KK-T3 **X X** A1278-XX-T3
- L L** A1278-LL-T3 **Y Y** A1278-YY-T3
- M M** A1278-MM-T3 **Z Z** A1278-ZZ-T3



SET# A1278-50-T3 (INCLUDES TRAY)

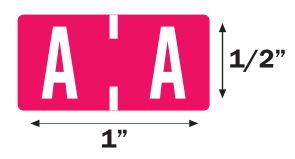

TBAV SERIES

TAB PRODUCTS MATCH
Fluorescent Colors Vinyl 500/Roll

- A A** TBAV-AA-S4 **N N** TBAV-NN-S4
- B B** TBAV-BB-S4 **O O** TBAV-OO-S4
- C C** TBAV-CC-S4 **P P** TBAV-PP-S4
- D D** TBAV-DD-S4 **Q Q** TBAV-QQ-S4
- E E** TBAV-EE-S4 **R R** TBAV-RR-S4
- F F** TBAV-FF-S4 **S S** TBAV-SS-S4
- G G** TBAV-GG-S4 **T T** TBAV-TT-S4
- H H** TBAV-HH-S4 **U U** TBAV-UU-S4
- I I** TBAV-II-S4 **V V** TBAV-VV-S4
- J J** TBAV-JJ-S4 **W W** TBAV-WW-S4
- K K** TBAV-KK-S4 **X X** TBAV-XX-S4
- L L** TBAV-LL-S4 **Y Y** TBAV-YY-S4
- M M** TBAV-MM-S4 **Z Z** TBAV-ZZ-S4



SET# TBAV-AT-S4 (INCLUDES TRAY)

*Fluorescent Ink Color

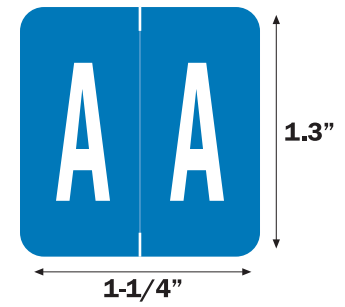

VRAM SERIES

VRE / GBS 8850 MATCH
Laminated 250/Roll

- A A** VRAM-AA-V3 **N N** VRAM-NN-V3
- B B** VRAM-BB-V3 **O O** VRAM-OO-V3
- C C** VRAM-CC-V3 **P P** VRAM-PP-V3
- D D** VRAM-DD-V3 **Q Q** VRAM-QQ-V3
- E E** VRAM-EE-V3 **R R** VRAM-RR-V3
- F F** VRAM-FF-V3 **S S** VRAM-SS-V3
- G G** VRAM-GG-V3 **T T** VRAM-TT-V3
- H H** VRAM-HH-V3 **U U** VRAM-UU-V3
- I I** VRAM-II-V3 **V V** VRAM-VV-V3
- J J** VRAM-JJ-V3 **W W** VRAM-WW-V3
- K K** VRAM-KK-V3 **X X** VRAM-XX-V3
- L L** VRAM-LL-V3 **Y Y** VRAM-YY-V3
- M M** VRAM-MM-V3 **Z Z** VRAM-ZZ-V3
- Mc Mc** VRAM-MC-V3



SET# VRAM-AT-V3 (INCLUDES TRAY)

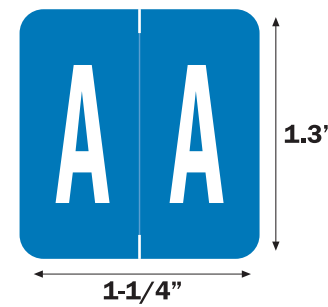

VRPK PACKS

GBS 8848 PACK MATCH
Laminated 200/Pack

- A A** VRPK-A **J J** VRPK-J **R R** VRPK-R
- B B** VRPK-B **K K** VRPK-K **S S** VRPK-S
- C C** VRPK-C **L L** VRPK-L **T T** VRPK-T
- D D** VRPK-D **M M** VRPK-M **U U** VRPK-U
- E E** VRPK-E **Mc Mc** VRPK-MC **V V** VRPK-V
- F F** VRPK-F **N N** VRPK-N **W W** VRPK-W
- G G** VRPK-G **O O** VRPK-O **X X** VRPK-X
- H H** VRPK-H **P P** VRPK-P **Y Y** VRPK-Y
- I I** VRPK-I **Q Q** VRPK-Q **Z Z** VRPK-Z

VRPK-RK
DESK REFILL PACK
1,010 ASSORTED
LABELS

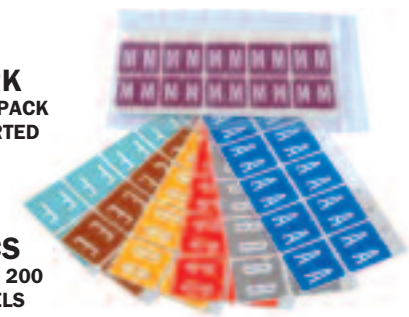

VRPK-CS
27 PACKS OF 200
5,400 LABELS

NUMERIC

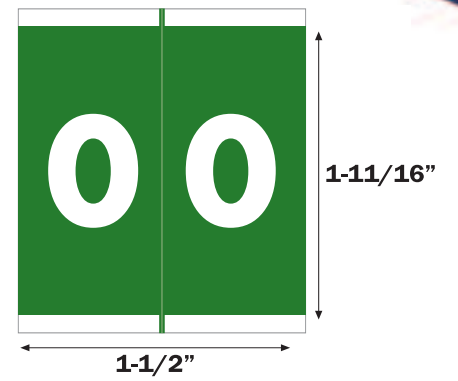

AVNM SERIES

BARKLEY FNAVM MATCH
Laminated 500/Roll

- 0 0** AVNM-00-L5 **5 5** AVNM-05-L5
- 1 1** AVNM-01-L5 **6 6** AVNM-06-L5
- 2 2** AVNM-02-L5 **7 7** AVNM-07-L5
- 3 3** AVNM-03-L5 **8 8** AVNM-08-L5
- 4 4** AVNM-04-L5 **9 9** AVNM-09-L5

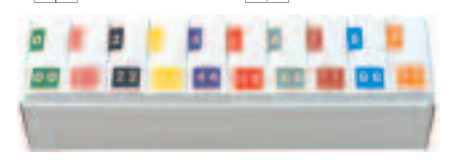

SET# AVNM-NT-L5 (INCLUDES TRAY)

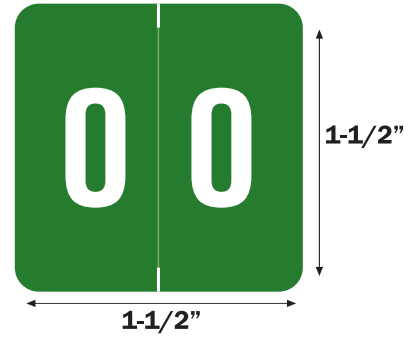

ACNM SERIES

ACME MATCH
Laminated 500/Roll

- 0 0** ACNM-00-L5 **5 5** ACNM-05-L5
- 1 1** ACNM-01-L5 **6 6** ACNM-06-L5
- 2 2** ACNM-02-L5 **7 7** ACNM-07-L5
- 3 3** ACNM-03-L5 **8 8** ACNM-08-L5
- 4 4** ACNM-04-L5 **9 9** ACNM-09-L5



SET# ACNM-NT-L5 (INCLUDES TRAY)

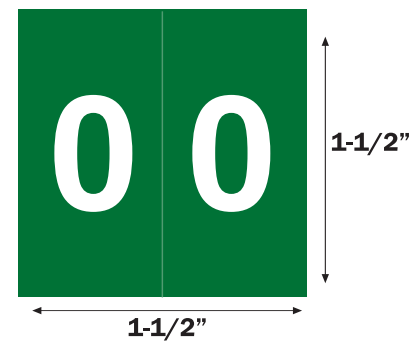

SWNM SERIES

S & W KKL MATCH
Laminated 500/Roll

- 0 0** SWNM-00-V3 **5 5** SWNM-05-V3
- 1 1** SWNM-01-V3 **6 6** SWNM-06-V3
- 2 2** SWNM-02-V3 **7 7** SWNM-07-V3
- 3 3** SWNM-03-V3 **8 8** SWNM-08-V3
- 4 4** SWNM-04-V3 **9 9** SWNM-09-V3



SET# SWNM-NT-V3 (INCLUDES TRAY)

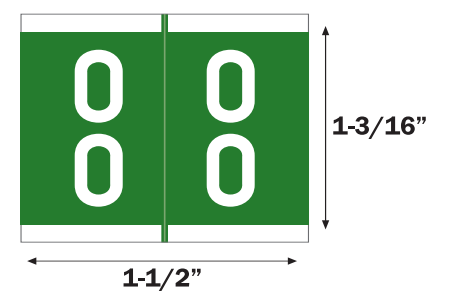

AVDM SERIES

BARKLEY FDAVM MATCH
Laminated 500/Roll

- 0 0** AVDM-00-L5 **5 5** AVDM-50-L5
- 1 1** AVDM-10-L5 **6 6** AVDM-60-L5
- 2 2** AVDM-20-L5 **7 7** AVDM-70-L5
- 3 3** AVDM-30-L5 **8 8** AVDM-80-L5
- 4 4** AVDM-40-L5 **9 9** AVDM-90-L5



SET# AVDM-NT-L5 (INCLUDES TRAY)

NUMERIC

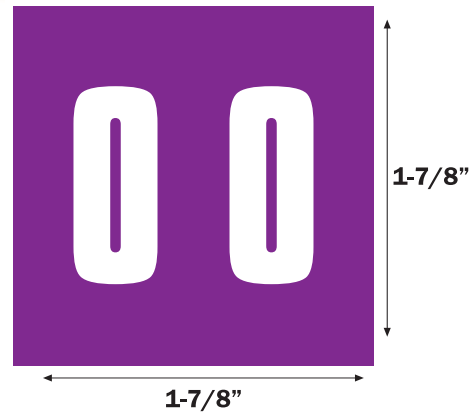

AFNP SERIES

IFC #CL2300 MATCH System #3
Unlaminated 500/Roll

00	AFNP-00-L5	55	AFNP-05-L5
11	AFNP-01-L5	66	AFNP-06-L5
22	AFNP-02-L5	77	AFNP-07-L5
33	AFNP-03-L5	88	AFNP-08-L5
44	AFNP-04-L5	99	AFNP-09-L5

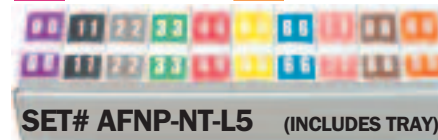

SET# AFNP-NT-L5 (INCLUDES TRAY)

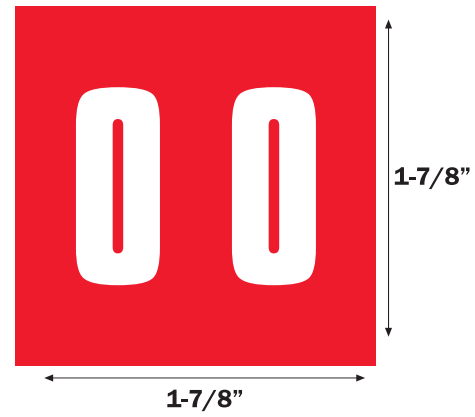

IFNP SERIES

IFC CL2100 MATCH System #1
Unlaminated 500/Roll

00	IFNP-00-L5	55	IFNP-05-L5
11	IFNP-01-L5	66	IFNP-06-L5
22	IFNP-02-L5	77	IFNP-07-L5
33	IFNP-03-L5	88	IFNP-08-L5
44	IFNP-04-L5	99	IFNP-09-L5

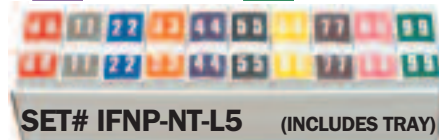

SET# IFNP-NT-L5 (INCLUDES TRAY)

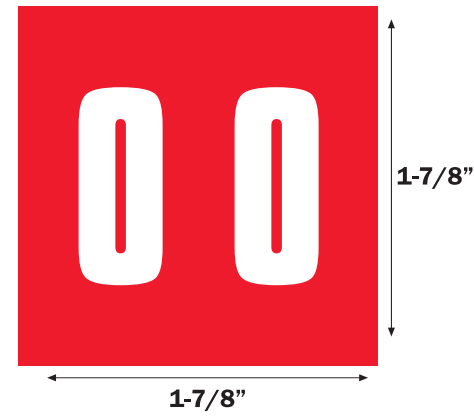

AMNP SERIES

AMES L-A-00178RL MATCH
Unlaminated 1000/Roll

00	AMNP-00-L5	55	AMNP-05-L5
11	AMNP-01-L5	66	AMNP-06-L5
22	AMNP-02-L5	77	AMNP-07-L5
33	AMNP-03-L5	88	AMNP-08-L5
44	AMNP-04-L5	99	AMNP-09-L5



SET# AMNP-NT-L5 (INCLUDES TRAY)

NUMERIC



AENP SERIES

AMES COLOR FILE
L-A-00134RB MATCH
Unlaminated 1000/Roll

00	AENP-00-B45	55	AENP-05-B45
11	AENP-01-B45	66	AENP-06-B45
22	AENP-02-B45	77	AENP-07-B45
33	AENP-03-B45	88	AENP-08-B45
44	AENP-04-B45	99	AENP-09-B45

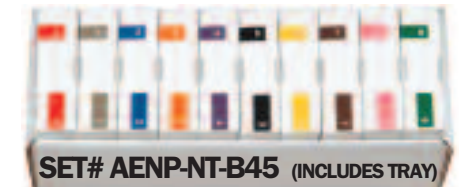

SET# AENP-NT-B45 (INCLUDES TRAY)

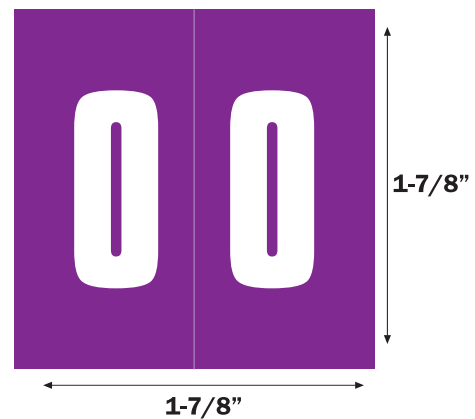

AFNM SERIES

IFC #CL3300 MATCH System #3
Laminated 500/Roll

00	AFNM-00-L5	55	AFNM-05-L5
11	AFNM-01-L5	66	AFNM-06-L5
22	AFNM-02-L5	77	AFNM-07-L5
33	AFNM-03-L5	88	AFNM-08-L5
44	AFNM-04-L5	99	AFNM-09-L5



SET# AFNM-NT-L5 (INCLUDES TRAY)

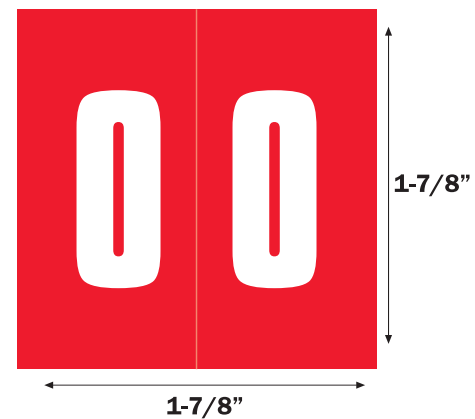

IFNM SERIES

IFC #CL3100 MATCH System #1
Laminated 500/Roll

00	IFNM-00-L5	55	IFNM-05-L5
11	IFNM-01-L5	66	IFNM-06-L5
22	IFNM-02-L5	77	IFNM-07-L5
33	IFNM-03-L5	88	IFNM-08-L5
44	IFNM-04-L5	99	IFNM-09-L5



SET# IFNM-NT-L5 (INCLUDES TRAY)

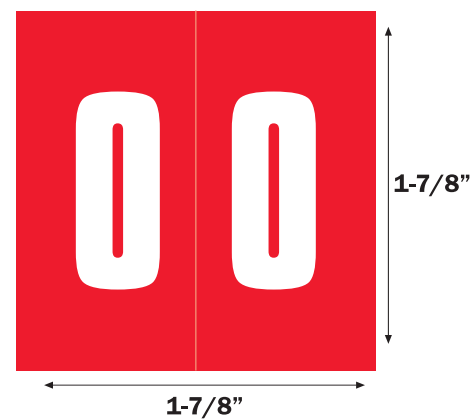

AMNM SERIES

AMES L-A-00178RLP MATCH
Laminated 500/Roll

00	AMNM-00-L5	55	AMNM-05-L5
11	AMNM-01-L5	66	AMNM-06-L5
22	AMNM-02-L5	77	AMNM-07-L5
33	AMNM-03-L5	88	AMNM-08-L5
44	AMNM-04-L5	99	AMNM-09-L5



SET# AMNM-NT-L5 (INCLUDES TRAY)

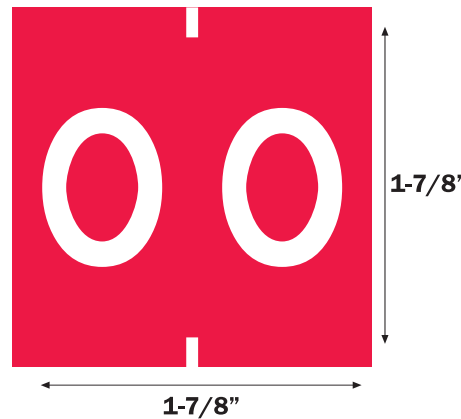

ASNP SERIES

AMES STRIP LABEL MATCH
Unlaminated 1000/Roll

00	ASNP-00-L5	55	ASNP-05-L5
11	ASNP-01-L5	66	ASNP-06-L5
22	ASNP-02-L5	77	ASNP-07-L5
33	ASNP-03-L5	88	ASNP-08-L5
44	ASNP-04-L5	99	ASNP-09-L5



SET# ASNP-NT-L5 (INCLUDES TRAY)

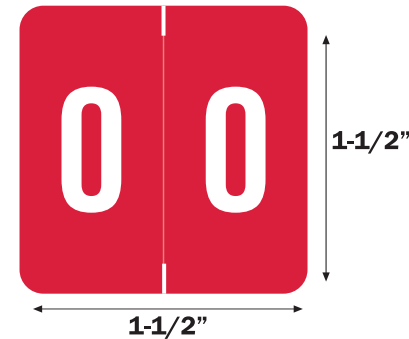
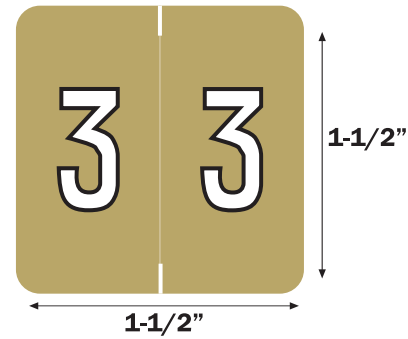
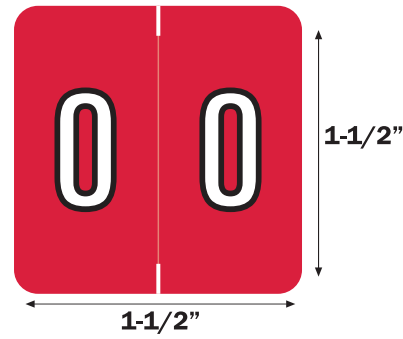

BKNM SERIES
BARKLEY FNBRM MATCH
Laminated 500/Roll

- 0 0 BKNM-00-L5 5 5 BKNM-05-L5
- 1 1 BKNM-01-L5 6 6 BKNM-06-L5
- 2 2 BKNM-02-L5 7 7 BKNM-07-L5
- 3 3 BKNM-03-L5 8 8 BKNM-08-L5
- 4 4 BKNM-04-L5 9 9 BKNM-09-L5



SET# BKNM-NT-L5 (INCLUDES TRAY)

BXNM SERIES
BARKLEY FNDBM MATCH
Laminated 500/Roll

- 0 0 BXNM-00-L5 5 5 BXNM-05-L5
- 1 1 BXNM-01-L5 6 6 BXNM-06-L5
- 2 2 BXNM-02-L5 7 7 BXNM-07-L5
- 3 3 BXNM-03-L5 8 8 BXNM-08-L5
- 4 4 BXNM-04-L5 9 9 BXNM-09-L5



SET# BXNM-NT-L5 (INCLUDES TRAY)

BENM SERIES
BARKLEY FNDBM-S MATCH
Laminated 500/Roll

- 0 0 BENM-00-L5 5 5 BENM-05-L5
- 1 1 BENM-01-L5 6 6 BENM-06-L5
- 2 2 BENM-02-L5 7 7 BENM-07-L5
- 3 3 BENM-03-L5 8 8 BENM-08-L5
- 4 4 BENM-04-L5 9 9 BENM-09-L5



SET# BENM-NT-L5 (INCLUDES TRAY)

BANM SERIES
BARKLEY FNBM MATCH
Laminated 500/Roll

- 0 0 BANM-00-S4 5 5 BANM-05-S4
- 1 1 BANM-01-S4 6 6 BANM-06-S4
- 2 2 BANM-02-S4 7 7 BANM-07-S4
- 3 3 BANM-03-S4 8 8 BANM-08-S4
- 4 4 BANM-04-S4 9 9 BANM-09-S4



SET# BANM-NT-S4 (INCLUDES TRAY)

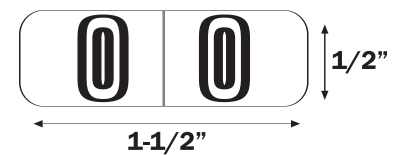
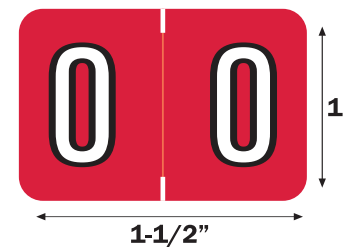
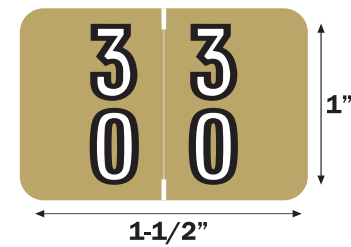
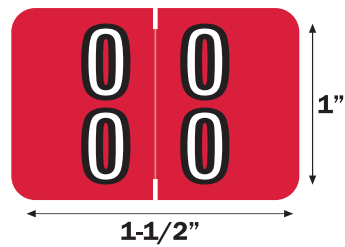

BADM SERIES
BARKLEY FDBKM MATCH
Laminated 500/Roll

- 0 0 BADM-00-B45 5 5 BADM-50-B45
- 1 1 BADM-10-B45 6 6 BADM-60-B45
- 2 2 BADM-20-B45 7 7 BADM-70-B45
- 3 3 BADM-30-B45 8 8 BADM-80-B45
- 4 4 BADM-40-B45 9 9 BADM-90-B45



SET# BADM-NT-B45 (INCLUDES TRAY)

BXDM SERIES
BARKLEY FDBM MATCH
Laminated 500/Roll

- 0 0 BXDM-00-B45 5 5 BXDM-50-B45
- 1 1 BXDM-10-B45 6 6 BXDM-60-B45
- 2 2 BXDM-20-B45 7 7 BXDM-70-B45
- 3 3 BXDM-30-B45 8 8 BXDM-80-B45
- 4 4 BXDM-40-B45 9 9 BXDM-90-B45



SET# BXDM-NT-B45 (INCLUDES TRAY)

BRNM SERIES
BARKLEY FNBKM MATCH
Laminated 500/Roll

- 0 0 BRNM-00-B45 5 5 BRNM-05-B45
- 1 1 BRNM-01-B45 6 6 BRNM-06-B45
- 2 2 BRNM-02-B45 7 7 BRNM-07-B45
- 3 3 BRNM-03-B45 8 8 BRNM-08-B45
- 4 4 BRNM-04-B45 9 9 BRNM-09-B45



SET# BRNM-NT-B45 (INCLUDES TRAY)

BYNM SERIES
BARKLEY FNBWM MATCH
Laminated 500/Roll

- 0 0 BYNM-00-S4 5 5 BYNM-05-S4
- 1 1 BYNM-01-S4 6 6 BYNM-06-S4
- 2 2 BYNM-02-S4 7 7 BYNM-07-S4
- 3 3 BYNM-03-S4 8 8 BYNM-08-S4
- 4 4 BYNM-04-S4 9 9 BYNM-09-S4



SET# BYNM-NT-S4 (INCLUDES TRAY)

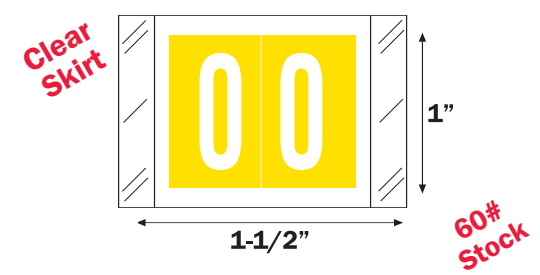

CTNM SERIES
BARKLEY FNSTM MATCH
Laminated 500/Roll

- | | |
|------------|------------|
| CTNM-00-V3 | CTNM-05-V3 |
| CTNM-01-V3 | CTNM-06-V3 |
| CTNM-02-V3 | CTNM-07-V3 |
| CTNM-03-V3 | CTNM-08-V3 |
| CTNM-04-V3 | CTNM-09-V3 |



SET# CTNM-NT-V3 (INCLUDES TRAY)

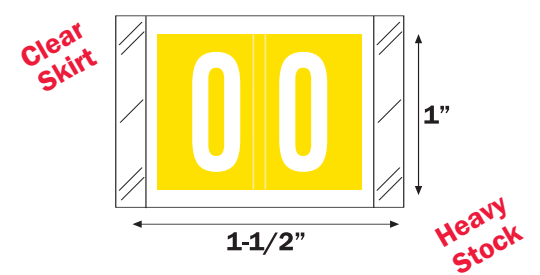

CRNM SERIES
TABBIES 11000 MATCH
Laminated 500/Roll

- | | |
|-------------|-------------|
| CRNM-00-CT5 | CRNM-05-CT5 |
| CRNM-01-CT5 | CRNM-06-CT5 |
| CRNM-02-CT5 | CRNM-07-CT5 |
| CRNM-03-CT5 | CRNM-08-CT5 |
| CRNM-04-CT5 | CRNM-09-CT5 |



SET# CRNM-NT-CT5 (INCLUDES TRAY)

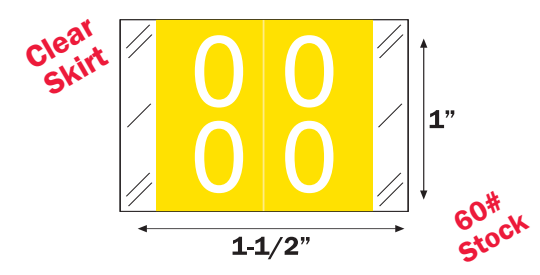

CTDM SERIES
BARKLEY FDSTM MATCH
Laminated 500/Roll

- | | |
|------------|------------|
| CTDM-00-V3 | CTDM-50-V3 |
| CTDM-10-V3 | CTDM-60-V3 |
| CTDM-20-V3 | CTDM-70-V3 |
| CTDM-30-V3 | CTDM-80-V3 |
| CTDM-40-V3 | CTDM-90-V3 |



SET# CTDM-NT-V3 (INCLUDES TRAY)

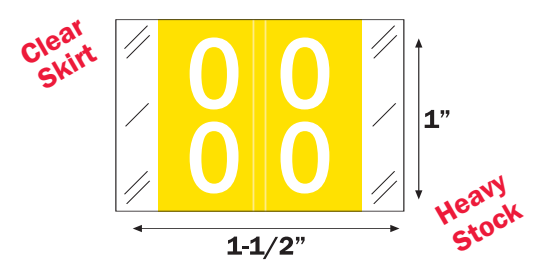

CRDM SERIES
TABBIES 11200 MATCH
Laminated 500/Roll

- | | |
|-------------|-------------|
| CRDM-00-CT5 | CRDM-50-CT5 |
| CRDM-10-CT5 | CRDM-60-CT5 |
| CRDM-20-CT5 | CRDM-70-CT5 |
| CRDM-30-CT5 | CRDM-80-CT5 |
| CRDM-40-CT5 | CRDM-90-CT5 |

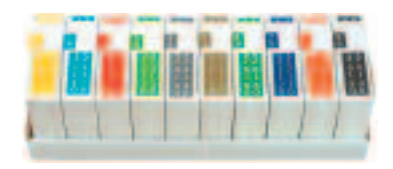

SET# CRDM-NT-CT5 (INCLUDES TRAY)

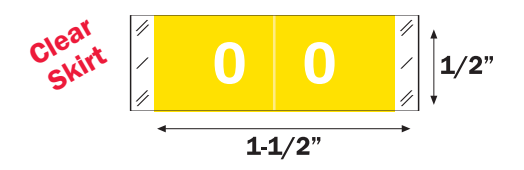

CBNM SERIES
TABBIES 11850 MATCH
Laminated 500/Roll

- | | |
|-------------|-------------|
| CBNM-00-CT5 | CBNM-07-CT5 |
| CBNM-01-CT5 | CBNM-08-CT5 |
| CBNM-02-CT5 | CBNM-09-CT5 |
| CBNM-03-CT5 | CBNM-10-CT5 |
| CBNM-04-CT5 | CBNM-11-CT5 |
| CBNM-05-CT5 | CBNM-12-CT5 |
| CBNM-06-CT5 | |



SET# CBNM-NT-CT5 (INCLUDES TRAY)
*Set Includes 0 - 9 Only

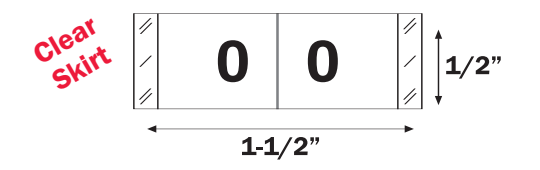

CBWM SERIES
TABBIES 11830 MATCH
Laminated 500/Roll

- | | |
|-------------|-------------|
| CBWM-00-CT5 | CBWM-07-CT5 |
| CBWM-01-CT5 | CBWM-08-CT5 |
| CBWM-02-CT5 | CBWM-09-CT5 |
| CBWM-03-CT5 | CBWM-10-CT5 |
| CBWM-04-CT5 | CBWM-11-CT5 |
| CBWM-05-CT5 | CBWM-12-CT5 |
| CBWM-06-CT5 | |



SET# CBWM-NT-CT5 (INCLUDES TRAY)
*Set Includes 0 - 9 Only

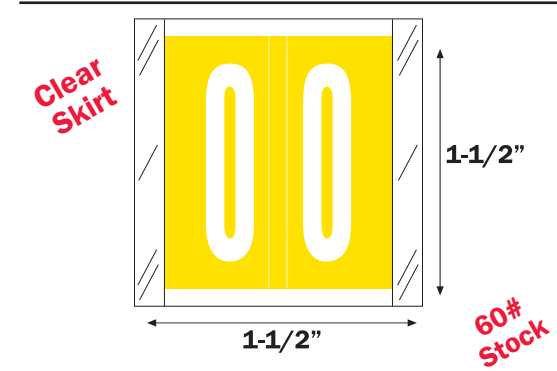

CSNM SERIES
BARKLEY FNSRM MATCH
Laminated 500/Roll

- | | |
|-------------|-------------|
| CSNM-00-CT5 | CSNM-05-CT5 |
| CSNM-01-CT5 | CSNM-06-CT5 |
| CSNM-02-CT5 | CSNM-07-CT5 |
| CSNM-03-CT5 | CSNM-08-CT5 |
| CSNM-04-CT5 | CSNM-09-CT5 |



SET# CSNM-NT-CT5 (INCLUDES TRAY)

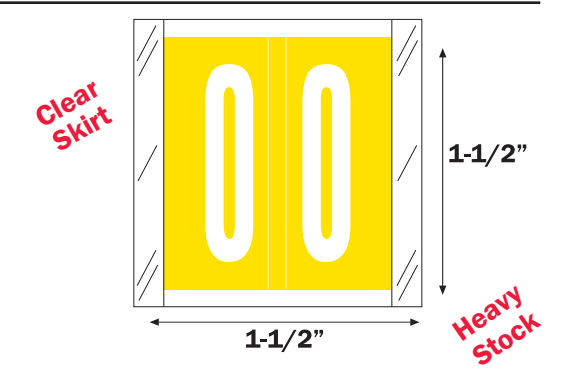

CLNM SERIES
TABBIES 11500 MATCH
Laminated 500/Roll

- | | |
|-------------|-------------|
| CLNM-00-CT5 | CLNM-05-CT5 |
| CLNM-01-CT5 | CLNM-06-CT5 |
| CLNM-02-CT5 | CLNM-07-CT5 |
| CLNM-03-CT5 | CLNM-08-CT5 |
| CLNM-04-CT5 | CLNM-09-CT5 |



SET# CLNM-NT-CT5 (INCLUDES TRAY)

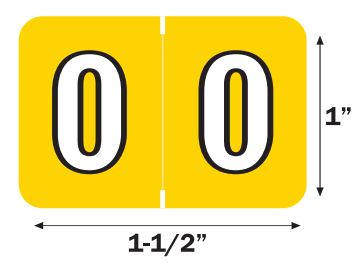

CONM SERIES
COLWELL JEWEL TONE MATCH
Laminated 500/Roll

- | | | | |
|----|------------|----|------------|
| 00 | CONM-00-T4 | 55 | CONM-05-T4 |
| 11 | CONM-01-T4 | 66 | CONM-06-T4 |
| 22 | CONM-02-T4 | 77 | CONM-07-T4 |
| 33 | CONM-03-T4 | 88 | CONM-08-T4 |
| 44 | CONM-04-T4 | 99 | CONM-09-T4 |



SET# CONM-NT-T4 (INCLUDES TRAY)



AL8700 SERIES
DATAFILE / TAB L8700 MATCH
Laminated 500/Roll

- | | | | |
|----|--------------|----|--------------|
| 00 | AL8700-00-T3 | 55 | AL8700-05-T3 |
| 11 | AL8700-01-T3 | 66 | AL8700-06-T3 |
| 22 | AL8700-02-T3 | 77 | AL8700-07-T3 |
| 33 | AL8700-03-T3 | 88 | AL8700-08-T3 |
| 44 | AL8700-04-T3 | 99 | AL8700-09-T3 |



SET# AL8700-50-T3 (INCLUDES TRAY)

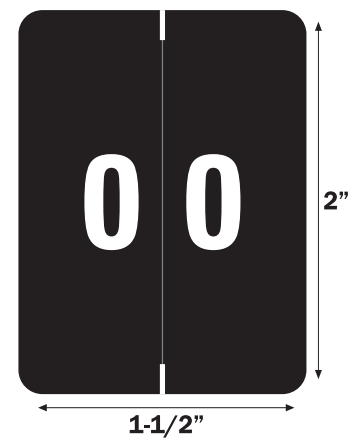

KDNM SERIES
KARDEX MATCH
Laminated 500/Roll

- | | | | |
|----|------------|----|------------|
| 00 | KDNM-00-L5 | 55 | KDNM-05-L5 |
| 11 | KDNM-01-L5 | 66 | KDNM-06-L5 |
| 22 | KDNM-02-L5 | 77 | KDNM-07-L5 |
| 33 | KDNM-03-L5 | 88 | KDNM-08-L5 |
| 44 | KDNM-04-L5 | 99 | KDNM-09-L5 |



SET# KDNM-NT-L5 (INCLUDES TRAY)

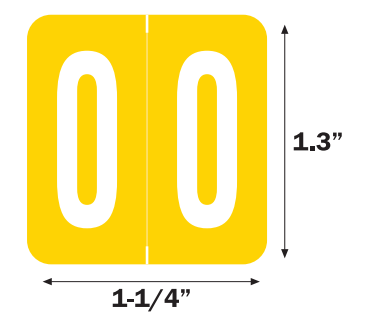

VRNM SERIES
VRE / GBS 8860 MATCH Syst. #1
Laminated 500/Roll

- | | | | |
|----|------------|----|------------|
| 00 | VRNM-00-V3 | 55 | VRNM-05-V3 |
| 11 | VRNM-01-V3 | 66 | VRNM-06-V3 |
| 22 | VRNM-02-V3 | 77 | VRNM-07-V3 |
| 33 | VRNM-03-V3 | 88 | VRNM-08-V3 |
| 44 | VRNM-04-V3 | 99 | VRNM-09-V3 |



SET# VRNM-NT-V3 (INCLUDES TRAY)

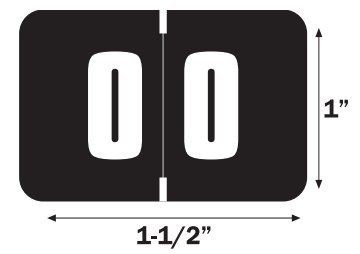

DCNM SERIES
DIGI COLOR MATCH
Laminated 250/Roll

- | | | | |
|----|------------|----|------------|
| 00 | DCNM-00-T4 | 55 | DCNM-05-T4 |
| 11 | DCNM-01-T4 | 66 | DCNM-06-T4 |
| 22 | DCNM-02-T4 | 77 | DCNM-07-T4 |
| 33 | DCNM-03-T4 | 88 | DCNM-08-T4 |
| 44 | DCNM-04-T4 | 99 | DCNM-09-T4 |



SET# DCNM-NT-T4 (INCLUDES TRAY)

* Fluorescent Ink Color

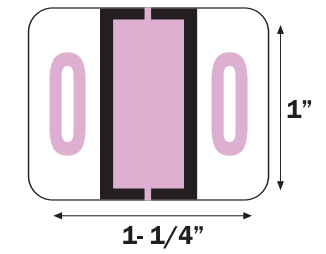

FDNV SERIES
FILE DOCTOR MATCH
Vinyl 500/Roll

- | | | | |
|----|-------------|----|------------|
| 00 | FDNV-00-T4 | 55 | FDNV-05-T4 |
| 11 | FDNV-01-T4* | 66 | FDNV-06-T4 |
| 22 | FDNV-02-T4* | 77 | FDNV-07-T4 |
| 33 | FDNV-03-T4 | 88 | FDNV-08-T4 |
| 44 | FDNV-04-T4 | 99 | FDNV-09-T4 |

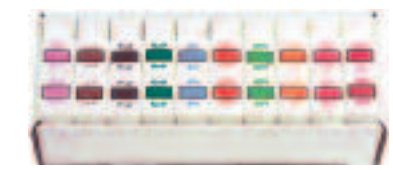

SET# FDNV-NT-T4 (INCLUDES TRAY)

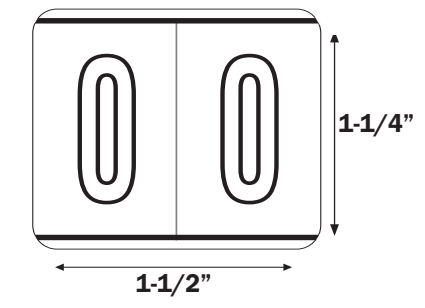

KXNM SERIES
KARDEX PSF-138 MATCH
Laminated 500/Roll

- | | | | |
|----|-------------|----|-------------|
| 00 | KXNM-00-L5R | 55 | KXNM-05-L5R |
| 11 | KXNM-01-L5R | 66 | KXNM-06-L5R |
| 22 | KXNM-02-L5R | 77 | KXNM-07-L5R |
| 33 | KXNM-03-L5R | 88 | KXNM-08-L5R |
| 44 | KXNM-04-L5R | 99 | KXNM-09-L5R |



SET# KXNM-NT-L5R (INCLUDES TRAY)

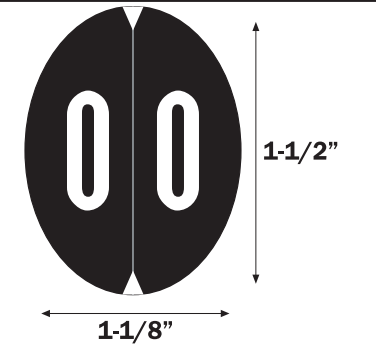

VONM SERIES
VRE / GBS 8857 MATCH - Syst. #6
Laminated 500/Roll

- | | | | |
|----|------------|----|------------|
| 00 | VONM-00-V3 | 55 | VONM-05-V3 |
| 11 | VONM-01-V3 | 66 | VONM-06-V3 |
| 22 | VONM-02-V3 | 77 | VONM-07-V3 |
| 33 | VONM-03-V3 | 88 | VONM-08-V3 |
| 44 | VONM-04-V3 | 99 | VONM-09-V3 |



SET# VONM-NT-V3 (INCLUDES TRAY)

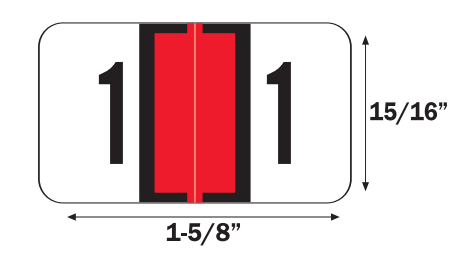

JANM SERIES
JETER 0300 MATCH
 Laminated 500/Roll

- 0 0 JANM-00-T4 5 5 JANM-05-T4
- 1 1 JANM-01-T4 6 6 JANM-06-T4
- 2 2 JANM-02-T4 7 7 JANM-07-T4
- 3 3 JANM-03-T4 8 8 JANM-08-T4
- * 4 4 JANM-04-T4 9 9 JANM-09-T4



SET# JANM-NT-T4 (INCLUDES TRAY) * Fluorescent Ink Color

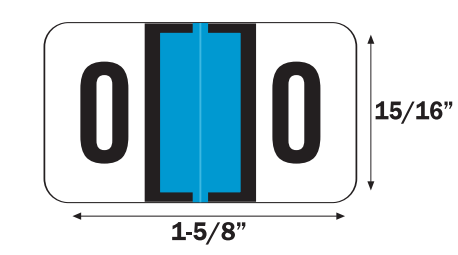

JENM SERIES
JETER 2600 MATCH
 Laminated 500/Roll

- 0 0 JENM-00-T4 5 5 JENM-05-T4
- 1 1 JENM-01-T4 6 6 JENM-06-T4
- 2 2 JENM-02-T4 7 7 JENM-07-T4
- 3 3 JENM-03-T4 8 8 JENM-08-T4
- 4 4 JENM-04-T4 9 9 JENM-09-T4



SET# JENM-NT-T4 (INCLUDES TRAY)

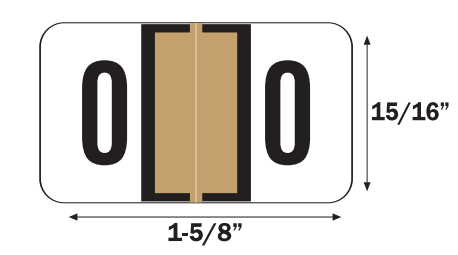

JTNM SERIES
JETER 7300 MATCH
 Laminated 500/Roll

- 0 0 JTNM-00-T4 5 5 JTNM-05-T4
- * 1 1 JTNM-01-T4 6 6 JTNM-06-T4
- 2 2 JTNM-02-T4 7 7 JTNM-07-T4
- 3 3 JTNM-03-T4 8 8 JTNM-08-T4
- 4 4 JTNM-04-T4 9 9 JTNM-09-T4



SET# JTNM-NT-T4 (INCLUDES TRAY) * Fluorescent Ink Color

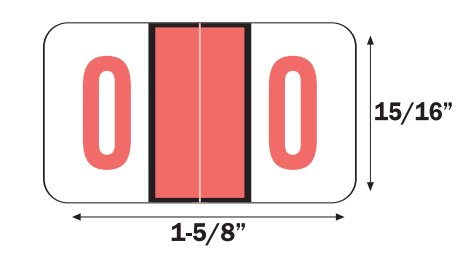

JRNM SERIES
JETER 6100/ TAB MATCH
 Laminated 500/Roll

- 0 0 JRNM-00-T4 5 5 JRNM-05-T4
- 1 1 JRNM-01-T4 6 6 JRNM-06-T4
- 2 2 JRNM-02-T4 7 7 JRNM-07-T4
- 3 3 JRNM-03-T4 8 8 JRNM-08-T4
- 4 4 JRNM-04-T4 9 9 JRNM-09-T4



SET# JRNM-NT-T4 (INCLUDES TRAY)

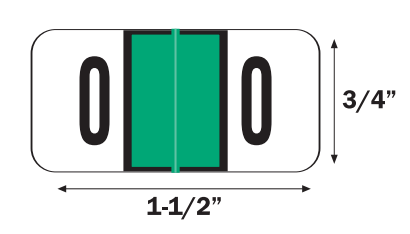

JSNM SERIES
JETER 3000 MATCH
 Laminated 500/Roll

- 0 0 JSNM-00-T4 5 5 JSNM-05-T4
- 1 1 JSNM-01-T4 6 6 JSNM-06-T4
- 2 2 JSNM-02-T4 7 7 JSNM-07-T4
- 3 3 JSNM-03-T4 8 8 JSNM-08-T4
- 4 4 JSNM-04-T4 9 9 JSNM-09-T4



SET# JSNM-NT-T4 (INCLUDES TRAY)

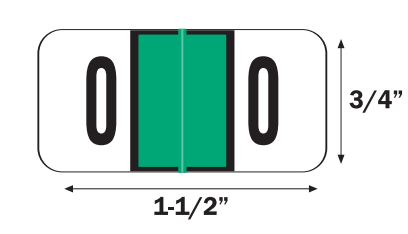

JSN3 SERIES
JETER 7400 MATCH
 Laminated 270/Pack

- 0 0 JSN3-0 5 5 JSN3-5
- 1 1 JSN3-1 6 6 JSN3-6
- 2 2 JSN3-2 7 7 JSN3-7
- 3 3 JSN3-3 8 8 JSN3-8
- 4 4 JSN3-4 9 9 JSN3-9

JSN3-RK
 BINDER REFILL
 4,050 ASSORTED LABELS

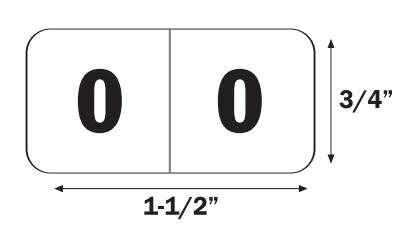

JBWM SERIES
JETER 4500 MATCH
 Laminated 500/Roll

- 0 0 JBWM-00-T4 5 5 JBWM-05-T4
- 1 1 JBWM-01-T4 6 6 JBWM-06-T4
- 2 2 JBWM-02-T4 7 7 JBWM-07-T4
- 3 3 JBWM-03-T4 8 8 JBWM-08-T4
- 4 4 JBWM-04-T4 9 9 JBWM-09-T4

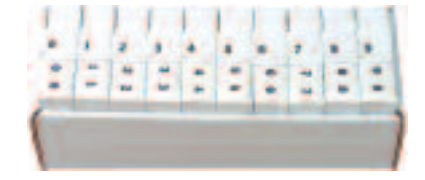

SET# JBWM-NT-T4 (INCLUDES TRAY)

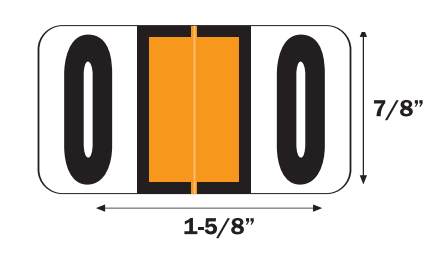

RRRM SERIES
REYNOLDS & REYNOLDS MATCH
 Laminated 500/Roll

- 0 0 RRRM-00-T4 5 5 RRRM-05-T4
- 1 1 RRRM-01-T4 6 6 RRRM-06-T4
- 2 2 RRRM-02-T4 7 7 RRRM-07-T4
- 3 3 RRRM-03-T4 8 8 RRRM-08-T4
- 4 4 RRRM-04-T4 9 9 RRRM-09-T4



SET# RRRM-NT-T4 (INCLUDES TRAY)

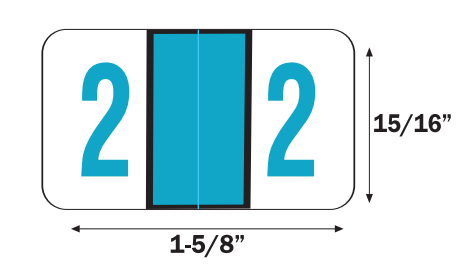

JXNM SERIES
JETER 6190 MATCH
 Laminated 500/Roll

- 0 0 JXNM-00-T4 5 5 JXNM-05-T4
- 1 1 JXNM-01-T4 6 6 JXNM-06-T4
- 2 2 JXNM-02-T4 7 7 JXNM-07-T4
- 3 3 JXNM-03-T4 8 8 JXNM-08-T4
- 4 4 JXNM-04-T4 9 9 JXNM-09-T4



SET# JXNM-NT-T4 (INCLUDES TRAY)

NUMERIC

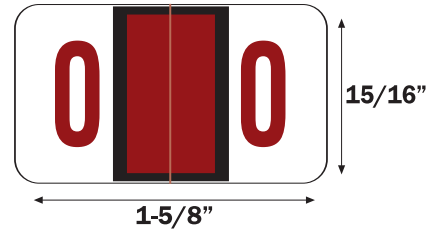

PONM SERIES

POS 3500 MATCH

Laminated 500/Roll

- 0 0 PONM-00-T4 5 5 PONM-05-T4
- 1 1 PONM-01-T4 6 6 PONM-06-T4
- 2 2 PONM-02-T4 7 7 PONM-07-T4
- 3 3 PONM-03-T4 8 8 PONM-08-T4
- 4 4 PONM-04-T4 9 9 PONM-09-T4



SET# PONM-NT-T4 (INCLUDES TRAY)



SGNM SERIES

SAFEGUARD MATCH

Laminated 500/Roll

- 0 0 SGNM-00-T4 * 5 5 SGNM-05-T4
- 1 1 SGNM-01-T4 6 6 SGNM-06-T4
- 2 2 SGNM-02-T4 7 7 SGNM-07-T4
- 3 3 SGNM-03-T4 8 8 SGNM-08-T4
- 4 4 SGNM-04-T4 9 9 SGNM-09-T4

* Fluorescent Ink Color



SET# SGNM-NT-T4 (INCLUDES TRAY)

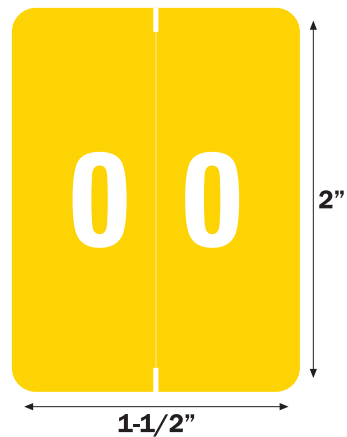

SMNM SERIES

SMEAD XLCC MATCH

IFC #CL3200 MATCH

Laminated 500/Roll

- 0 0 SMNM-00-L5 5 5 SMNM-05-L5
- 1 1 SMNM-01-L5 6 6 SMNM-06-L5
- 2 2 SMNM-02-L5 7 7 SMNM-07-L5
- 3 3 SMNM-03-L5 8 8 SMNM-08-L5
- 4 4 SMNM-04-L5 9 9 SMNM-09-L5



SET# SMNM-NT-L5 (INCLUDES TRAY)

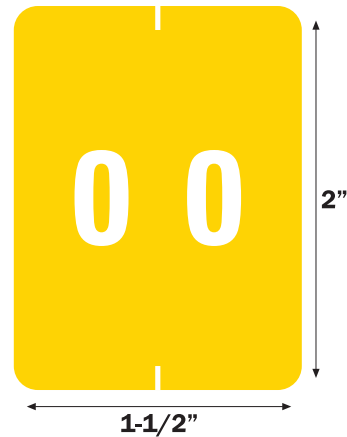

SMNP SERIES

IFC #CL2200 MATCH

Unlaminated 500/Roll

- 0 0 SMNP-00-L5 5 5 SMNP-05-L5
- 1 1 SMNP-01-L5 6 6 SMNP-06-L5
- 2 2 SMNP-02-L5 7 7 SMNP-07-L5
- 3 3 SMNP-03-L5 8 8 SMNP-08-L5
- 4 4 SMNP-04-L5 9 9 SMNP-09-L5



SET# SMNP-NT-L5 (INCLUDES TRAY)

NUMERIC

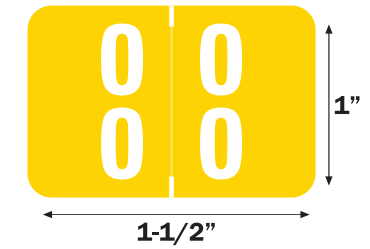

SMDM SERIES

SMEAD DDS MATCH

Laminated 500/Roll

- 0 0 SMDM-00-T4 5 5 SMDM-50-T4
- 1 1 SMDM-10-T4 6 6 SMDM-60-T4
- 2 2 SMDM-20-T4 7 7 SMDM-70-T4
- 3 3 SMDM-30-T4 8 8 SMDM-80-T4
- 4 4 SMDM-40-T4 9 9 SMDM-90-T4



SET# SMDM-NT-T4 (INCLUDES TRAY)

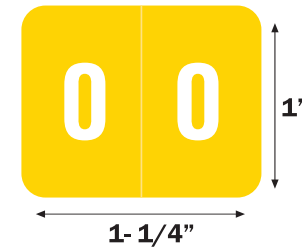

SENM SERIES

SMEAD DCCRN NUMERIC MATCH

Laminated 500/Roll

- 0 0 SENM-00-T4 5 5 SENM-05-T4
- 1 1 SENM-01-T4 6 6 SENM-06-T4
- 2 2 SENM-02-T4 7 7 SENM-07-T4
- 3 3 SENM-03-T4 8 8 SENM-08-T4
- 4 4 SENM-04-T4 9 9 SENM-09-T4



SET# SENM-NT-T4 (INCLUDES TRAY)

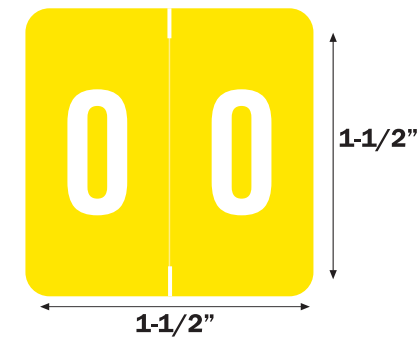

SBNM SERIES

SMEAD / BARKLEY FNSDM MATCH

Laminated 1000/Roll

- 0 0 SBNM-00-L5 5 5 SBNM-05-L5
- 1 1 SBNM-01-L5 6 6 SBNM-06-L5
- 2 2 SBNM-02-L5 7 7 SBNM-07-L5
- 3 3 SBNM-03-L5 8 8 SBNM-08-L5
- 4 4 SBNM-04-L5 9 9 SBNM-09-L5



SET# SBNM-NT-L5 (INCLUDES TRAY)

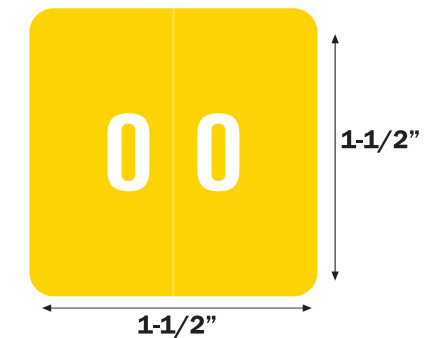

SDNM SERIES

SMEAD DCC MATCH

Laminated 250/Roll

- 0 0 SDNM-00-V3 5 5 SDNM-05-V3
- 1 1 SDNM-01-V3 6 6 SDNM-06-V3
- 2 2 SDNM-02-V3 7 7 SDNM-07-V3
- 3 3 SDNM-03-V3 8 8 SDNM-08-V3
- 4 4 SDNM-04-V3 9 9 SDNM-09-V3



SET# SDNM-NT-V3 (INCLUDES TRAY)

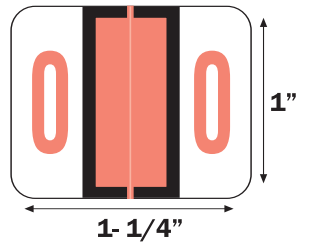

TPNM SERIES
SMEAD BCCRN MATCH
 Laminated 500/Roll

- 0 0 TPNM-00-T4 5 5 TPNM-05-T4
- 1 1 TPNM-01-T4 6 6 TPNM-06-T4
- * 2 2 TPNM-02-T4 7 7 TPNM-07-T4
- 3 3 TPNM-03-T4 8 8 TPNM-08-T4
- * 4 4 TPNM-04-T4 9 9 TPNM-09-T4



SET# TPNM-NT-T4 (INCLUDES TRAY)
 * Fluorescent Ink Color

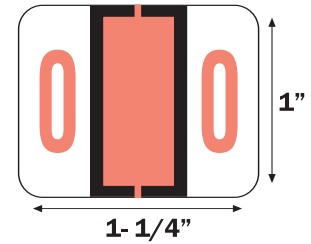

TPNV SERIES
TAB PRODUCTS MATCH
 Fluorescent Colors Vinyl 500/Roll

- 0 0 TPNV-00-T4 5 5 TPNV-05-T4
- 1 1 TPNV-01-T4 6 6 TPNV-06-T4
- * 2 2 TPNV-02-T4 7 7 TPNV-07-T4
- 3 3 TPNV-03-T4 8 8 TPNV-08-T4
- * 4 4 TPNV-04-T4 9 9 TPNV-09-T4



SET# TPNV-NT-T4 (INCLUDES TRAY)
 * Fluorescent Ink Color

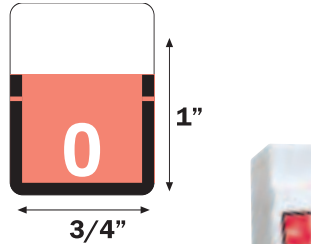

A1306 SERIES
TAB PRODUCTS 1306 MATCH
 New Tab Colors Vinyl 500/Roll

- 0 A1306-00-T3 5 A1306-05-T3
- 1 A1306-01-T3 6 A1306-06-T3
- 2 A1306-02-T3 7 A1306-07-T3
- 3 A1306-03-T3 8 A1306-08-T3
- 4 A1306-04-T3 9 A1306-09-T3



SET# A1306-50-T3 (INCLUDES TRAY)

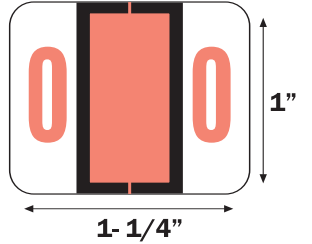

A1282 SERIES
TAB PRODUCTS 1282 MATCH
 New Tab Colors Vinyl 500/Roll

- 0 0 A1282-00-T3 5 5 A1282-05-T3
- 1 1 A1282-01-T3 6 6 A1282-06-T3
- 2 2 A1282-02-T3 7 7 A1282-07-T3
- 3 3 A1282-03-T3 8 8 A1282-08-T3
- 4 4 A1282-04-T3 9 9 A1282-09-T3



SET# A1282-50-T3 (INCLUDES TRAY)

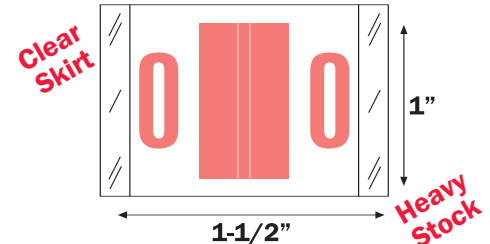

TTNM SERIES
TABBIES 14000 MATCH
 Laminated 500/Roll

- 0 0 TTNM-00-CT5 5 5 TTNM-05-CT5
- 1 1 TTNM-01-CT5 6 6 TTNM-06-CT5
- * 2 2 TTNM-02-CT5 7 7 TTNM-07-CT5
- 3 3 TTNM-03-CT5 8 8 TTNM-08-CT5
- * 4 4 TTNM-04-CT5 9 9 TTNM-09-CT5



SET# TTNM-NT-CT5 (INCLUDES TRAY)
 * Fluorescent Ink Color

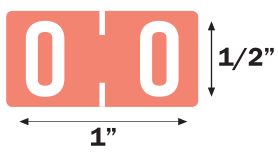

TBNV SERIES
TAB PRODUCTS MATCH
 Fluorescent Colors Vinyl 500/Roll

- 0 0 TBNV-00-S4 5 5 TBNV-05-S4
- 1 1 TBNV-01-S4 6 6 TBNV-06-S4
- * 2 2 TBNV-02-S4 7 7 TBNV-07-S4
- 3 3 TBNV-03-S4 8 8 TBNV-08-S4
- * 4 4 TBNV-04-S4 9 9 TBNV-09-S4



SET# TBNV-NT-S4 (INCLUDES TRAY)
 * Fluorescent Ink Color

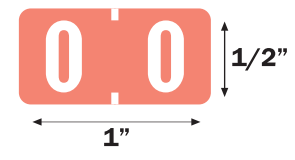

A1277 SERIES
TAB PRODUCTS 1277 MATCH
 New Tab Colors Vinyl 500/Roll

- 0 0 A1277-00-T3 5 5 A1277-05-T3
- 1 1 A1277-01-T3 6 6 A1277-06-T3
- 2 2 A1277-02-T3 7 7 A1277-07-T3
- 3 3 A1277-03-T3 8 8 A1277-08-T3
- 4 4 A1277-04-T3 9 9 A1277-09-T3



SET# A1277-50-T3 (INCLUDES TRAY)

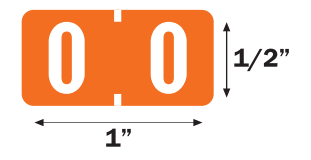

A1280 SERIES
TAB PRODUCTS 1280 MATCH
 New Tab Colors Vinyl 1000/Roll

- 0 0 A1280-00-T3 5 5 A1280-05-T3
- 1 1 A1280-01-T3 6 6 A1280-06-T3
- 2 2 A1280-02-T3 7 7 A1280-07-T3
- 3 3 A1280-03-T3 8 8 A1280-08-T3
- 4 4 A1280-04-T3 9 9 A1280-09-T3



SET# A1280-50-T3 (INCLUDES TRAY)

NUMERIC

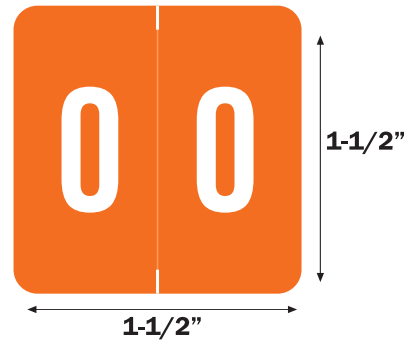

STNM SERIES
SAV-TYME / SFI MATCH
 Laminated 500/Roll

- | | | | |
|----|------------|----|------------|
| 00 | STNM-00-L5 | 55 | STNM-05-L5 |
| 11 | STNM-01-L5 | 66 | STNM-06-L5 |
| 22 | STNM-02-L5 | 77 | STNM-07-L5 |
| 33 | STNM-03-L5 | 88 | STNM-08-L5 |
| 44 | STNM-04-L5 | 99 | STNM-09-L5 |



SET# STNM-NT-L5 (INCLUDES TRAY)

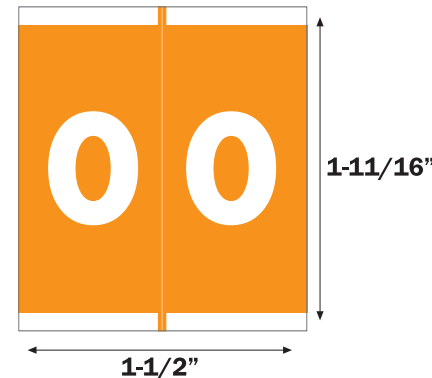

SFNM SERIES
BARKLEY FNSFM MATCH
 Laminated 500/Roll

- | | | | |
|----|------------|----|------------|
| 00 | SFNM-00-L5 | 55 | SFNM-05-L5 |
| 11 | SFNM-01-L5 | 66 | SFNM-06-L5 |
| 22 | SFNM-02-L5 | 77 | SFNM-07-L5 |
| 33 | SFNM-03-L5 | 88 | SFNM-08-L5 |
| 44 | SFNM-04-L5 | 99 | SFNM-09-L5 |



SET# SFNM-NT-L5 (INCLUDES TRAY)

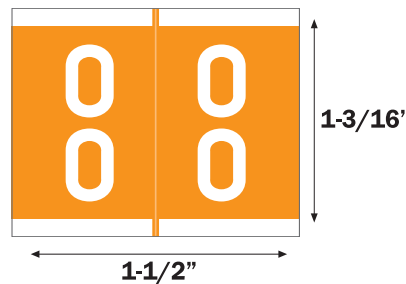

SFDM SERIES
BARKLEY FDSFM MATCH
 Laminated 500/Roll

- | | | | |
|----|------------|----|------------|
| 00 | SFDM-00-L5 | 50 | SFDM-50-L5 |
| 10 | SFDM-10-L5 | 60 | SFDM-60-L5 |
| 20 | SFDM-20-L5 | 70 | SFDM-70-L5 |
| 30 | SFDM-30-L5 | 80 | SFDM-80-L5 |
| 40 | SFDM-40-L5 | 90 | SFDM-90-L5 |



SET# SFDM-NT-L5 (INCLUDES TRAY)

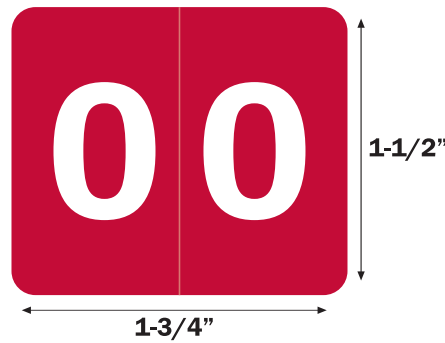

VANM SERIES
V.A. HOSPITAL / BARKLEY FNVAM MATCH
 Laminated 1000/Roll

- | | | | |
|----|------------|----|------------|
| 00 | VANM-00-L5 | 55 | VANM-05-L5 |
| 11 | VANM-01-L5 | 66 | VANM-06-L5 |
| 22 | VANM-02-L5 | 77 | VANM-07-L5 |
| 33 | VANM-03-L5 | 88 | VANM-08-L5 |
| 44 | VANM-04-L5 | 99 | VANM-09-L5 |



SET# VANM-NT-L5 (INCLUDES TRAY)

SOLID / CLASSIFICATION

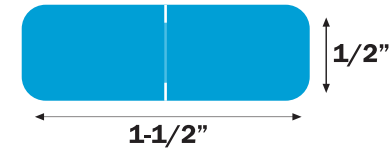

BALM SERIES
BARKLEY FXBAM MATCH
 Laminated 500/Roll

- | | |
|------------|------------|
| BALM-RD-S4 | BALM-LV-S4 |
| BALM-PK-S4 | BALM-BR-S4 |
| BALM-YL-S4 | BALM-GY-S4 |
| BALM-OR-S4 | BALM-GD-S4 |
| BALM-GR-S4 | BALM-BK-S4 |
| BALM-BL-S4 | BALM-WT-S4 |



BALM SERIES



ASLP SERIES
IFC #CL8100 MATCH
AMES L-A-00134 MATCH
 Unlaminated 1000/Roll

- | | |
|-------------|-------------|
| ASLP-RD-B45 | ASLP-BK-B45 |
| ASLP-GY-B45 | ASLP-YL-B45 |
| ASLP-BL-B45 | ASLP-BR-B45 |
| ASLP-OR-B45 | ASLP-PK-B45 |
| ASLP-PU-B45 | ASLP-GR-B45 |



SET# ASLP-LT-B45 (INCLUDES TRAY)

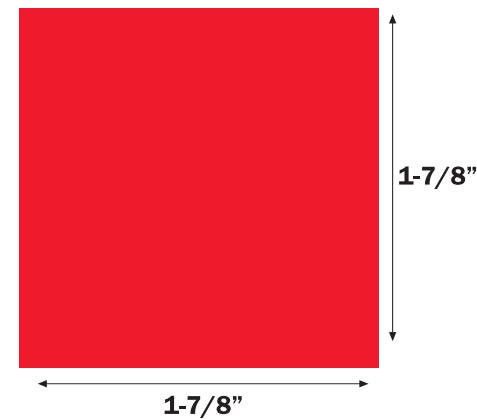

AMLP SERIES
IFC #CL1100 MATCH
AMES L-A-00178
 Unlaminated 500/Roll

- | | |
|------------|------------|
| AMLP-RD-L5 | AMLP-BK-L5 |
| AMLP-GY-L5 | AMLP-YL-L5 |
| AMLP-BL-L5 | AMLP-BR-L5 |
| AMLP-OR-L5 | AMLP-PK-L5 |
| AMLP-PU-L5 | AMLP-GR-L5 |

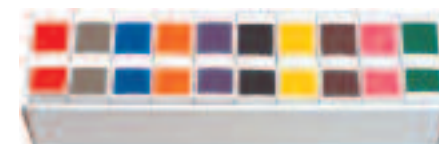

SET# AMLP-LT-L5 (INCLUDES TRAY)

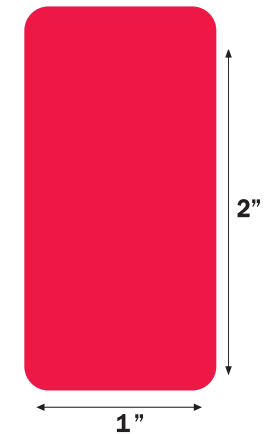

SMLP SERIES
SMEAD CC MATCH
 Unlaminated 250/Roll

- | | |
|------------|------------|
| SMLP-YL-T4 | SMLP-BR-T4 |
| SMLP-LB-T4 | SMLP-GR-T4 |
| SMLP-PK-T4 | SMLP-GY-T4 |
| SMLP-PU-T4 | SMLP-RD-T4 |
| SMLP-OR-T4 | SMLP-BK-T4 |



SET# SMLP-LT-T4 (INCLUDES TRAY)



A1281 SERIES
TAB PRODUCTS 1281 MATCH
 New Tab Colors Vinyl 1000/Roll

A1281-DG-T3	A1281-RD-T3
A1281-DB-T3	A1281-YL-T3
A1281-LB-T3	A1281-PK-T3
A1281-BR-T3	A1281-OR-T3
A1281-BK-T3	A1281-PU-T3
A1281-GY-T3	A1281-LG-T3



A1281-50-T3 (INCLUDES TRAY)

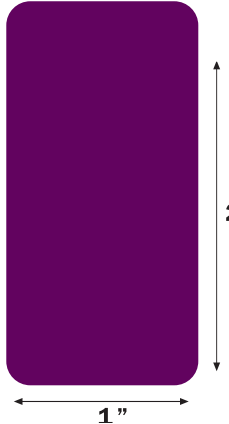

A1116 SERIES
TAB PRODUCTS 1116 MATCH
 Unlaminated 250/Roll

A1116-00-T3	A1116-05-T3
A1116-01-T3	A1116-06-T3
A1116-02-T3	A1116-07-T3
A1116-03-T3	A1116-08-T3
A1116-04-T3	A1116-09-T3



SET# A1116-50-T3 (INCLUDES TRAY)



TMLV SERIES
TAB PRODUCTS MATCH
 Old Tab Colors Vinyl 500/Roll

TMLV-JAN-S4	TMLV-JUL-S4
TMLV-FEB-S4	TMLV-AUG-S4
TMLV-MAR-S4	TMLV-SEP-S4
TMLV-APR-S4	TMLV-OCT-S4
TMLV-MAY-S4	TMLV-NOV-S4
TMLV-JUN-S4	TMLV-DEC-S4



SET# TMLV-NT-S4



A1279 SERIES
TAB PRODUCTS 1279 MATCH
 New Tab Colors Vinyl 1000/Roll

A1279-JAN-T3	A1279-JUL-T3
A1279-FEB-T3	A1279-AUG-T3
A1279-MAR-T3	A1279-SEP-T3
A1279-APR-T3	A1279-OCT-T3
A1279-MAY-T3	A1279-NOV-T3
A1279-JUN-T3	A1279-DEC-T3



SET# A1279-50-T3 (INCLUDES T3 TRAY)

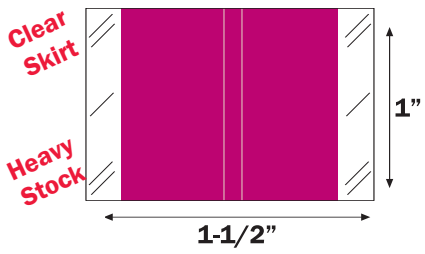

CRLM SERIES
TABBIES 11100 MATCH
 Laminated 500/Roll

CRLM-YL-CT5	CRLM-DB-CT5
CRLM-LB-CT5	CRLM-OR-CT5
CRLM-RD-CT5	CRLM-BK-CT5
CRLM-LG-CT5	CRLM-WT-CT5
CRLM-GY-CT5	CRLM-BR-CT5
CRLM-GD-CT5	CRLM-PK-CT5
CRLM-DG-CT5	CRLM-VT-CT5



CRLM SERIES

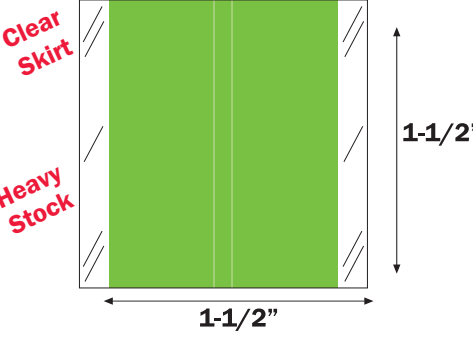

CLLM SERIES
TABBIES 11600 MATCH
 Laminated 500/Roll

CLLM-YL-CT5	CLLM-DB-CT5
CLLM-LB-CT5	CLLM-OR-CT5
CLLM-RD-CT5	CLLM-BK-CT5
CLLM-LG-CT5	CLLM-WT-CT5
CLLM-GY-CT5	CLLM-BR-CT5
CLLM-GD-CT5	CLLM-PK-CT5
CLLM-DG-CT5	CLLM-VT-CT5



CLLM SERIES



JTLM SERIES
JETER 9500 MATCH
 Laminated 500/Roll

JTLM-RD-T4	JTLM-BR-T4
JTLM-GY-T4	JTLM-PK-T4
JTLM-BL-T4	JTLM-GR-T4
JTLM-OR-T4	JTLM-WT-T4
JTLM-PU-T4	JTLM-LV-T4
JTLM-BK-T4	JTLM-GD-T4
JTLM-YL-T4	JTLM-TN-T4



JTLM SERIES



AFMP SERIES
IFC CL9200 MATCH
 Unlaminated 500/Roll

AFMP-JAN-S4	AFMP-JUL-S4
AFMP-FEB-S4	AFMP-AUG-S4
AFMP-MAR-S4	AFMP-SEP-S4
AFMP-APR-S4	AFMP-OCT-S4
AFMP-MAY-S4	AFMP-NOV-S4
AFMP-JUN-S4	AFMP-DEC-S4



SET# AFMP-NT-S4 (INCLUDES TRAY)

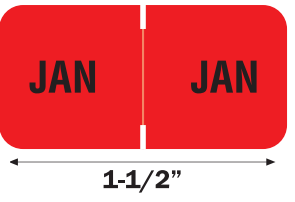

BAMM SERIES
BARKLEY FMBLM MATCH
 Mylar 250/Roll

BAMM-JAN-B45	BAMM-JUL-B45
BAMM-FEB-B45	BAMM-AUG-B45
BAMM-MAR-B45	BAMM-SEP-B45
BAMM-APR-B45	BAMM-OCT-B45
BAMM-MAY-B45	BAMM-NOV-B45
BAMM-JUN-B45	BAMM-DEC-B45



SET# BAMM-NT-B45

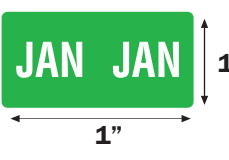

SMMK SERIES
SMEAD ETS MATCH
 Mylar 250/Pack

SMMK-JAN	SMMK-JUL
SMMK-FEB	SMMK-AUG
SMMK-MAR	SMMK-SEP
SMMK-APR	SMMK-OCT
SMMK-MAY	SMMK-NOV
SMMK-JUN	SMMK-DEC



SET# SMMK-PK



YEARBANDS

ACYM SERIES

S & W / ACME MATCH

3/4"H X 1-1/2"W

Laminated 500/Roll



VRYM SERIES

VRE / GBS MATCH

3/4"H X 1-1/2"W

Laminated 500/Roll



AAYM SERIES

AMES MATCH

3/4"H X 1-1/2"W

Laminated 500/Roll



AMYP SERIES

AMES MATCH

1-7/8"H X 1-7/8"W

Unlaminated 1000/Roll

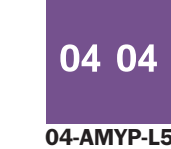
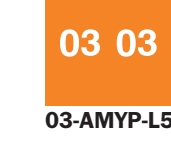
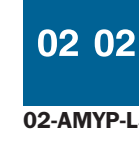
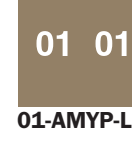

AEYM SERIES

AMES MATCH

1-7/8"H X 1-7/8"W

Laminated 500/Roll

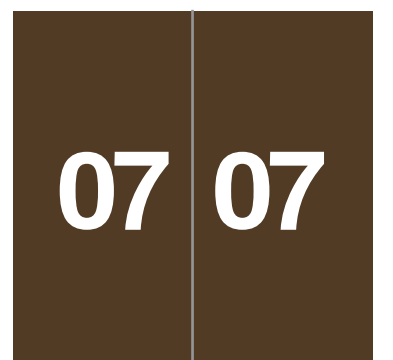
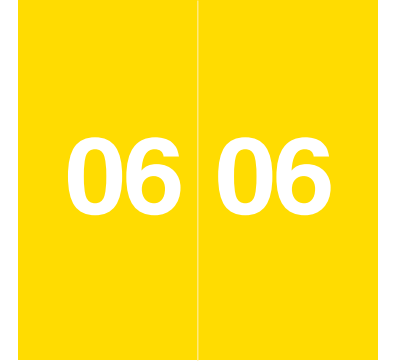
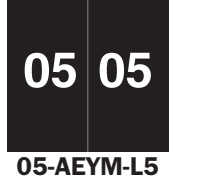
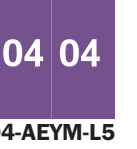
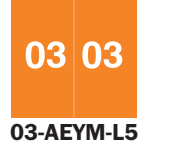

ARYM SERIES

AMERIFILE MATCH

3/4"H X 1-1/2"W

Laminated 500/Roll



BAYM/BEYM SERIES

BARKLEY MATCH

3/4"H X 1-1/2"W

Laminated 500/Roll



BKYM SERIES



IFYM SERIES

IFC CL7100 MATCH

1-7/8"H X 1-7/8"W

Laminated 500/Roll

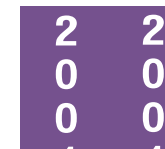
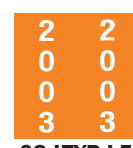
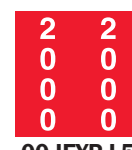
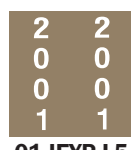
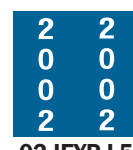
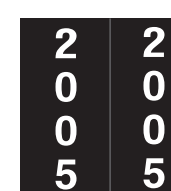
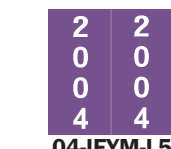
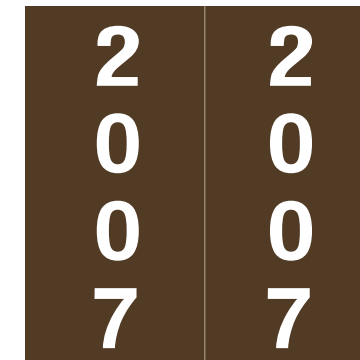
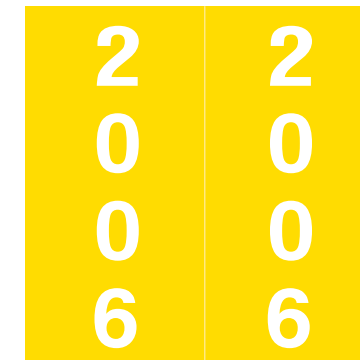

IFYP SERIES

IFC CL6100 MATCH

1-7/8"H X 1-7/8"W

Unlaminated 500/Roll

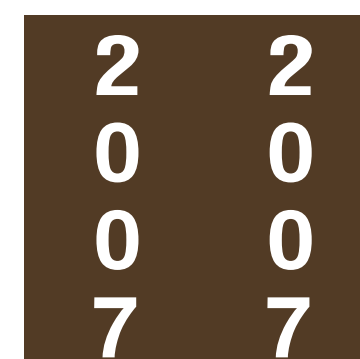
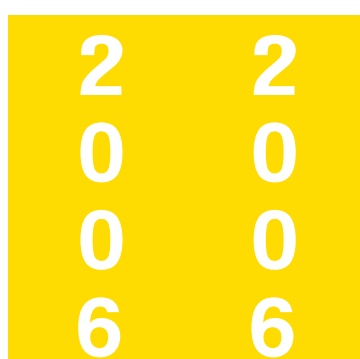
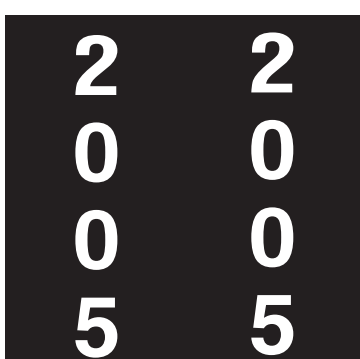

Future Year Colors To Be Announced

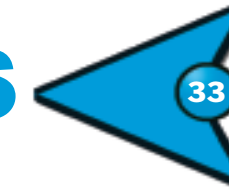

YEARBANDS

AFYM SERIES
IFC CL7300 MATCH
 1-7/8"H X 1-7/8"W
 Laminated 500/Roll

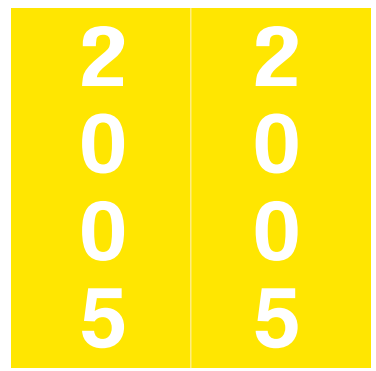

05-AFYM-L5

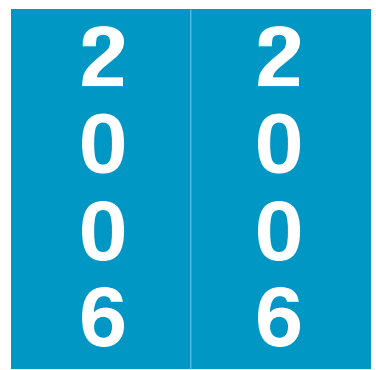

06-AFYM-L5

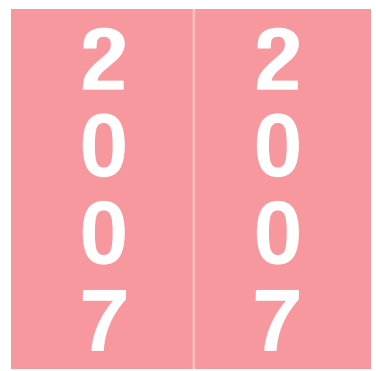

07-AFYM-L5

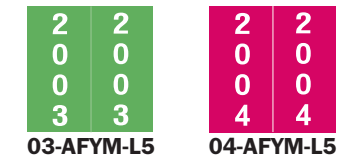

03-AFYM-L5 04-AFYM-L5

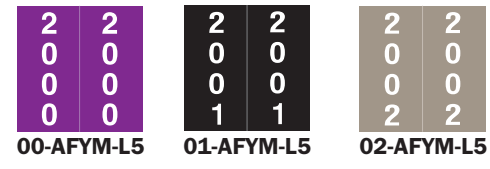

00-AFYM-L5 01-AFYM-L5 02-AFYM-L5

AFYP SERIES
IFC CL6300 MATCH
 1-7/8"H X 1-7/8"W
 Unlaminated 500/Roll

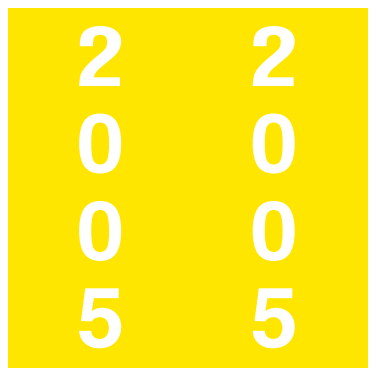

05-AFYP-L5

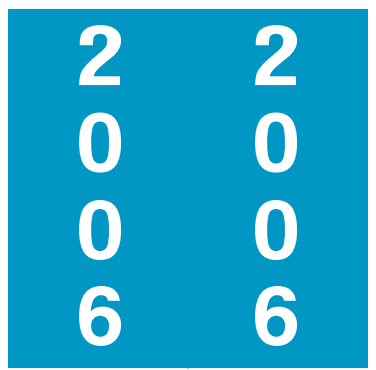

06-AFYP-L5

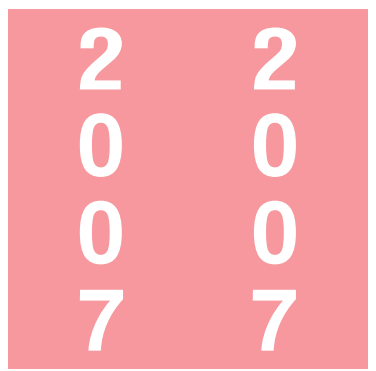

07-AFYP-L5

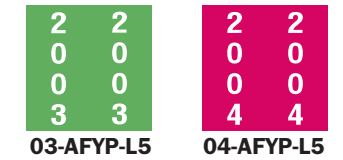

03-AFYP-L5 04-AFYP-L5



00-AFYP-L5 01-AFYP-L5 02-AFYP-L5

AMYM SERIES
AMES MATCH
 1/2"H X 1-1/2"W
 Laminated 500/Roll



05-AMYM-S4



06-AMYM-S4



07-AMYM-S4



03-AMYM-S4 04-AMYM-S4



01-AMYM-S4 02-AMYM-S4

ASYP SERIES
AMES / IFC CL6105 MATCH
 1/2"H X 1-3/4"W
 Unlaminated 1000/Roll



05-ASYP-B45



06-ASYP-B45



07-ASYP-B45



03-ASYP-B45 04-ASYP-B45



01-ASYP-B45 02-ASYP-B45

CFYM SERIES
CONTROL-O-FAX MATCH
 3/4"H X 1-1/2"W
 Laminated 500/Roll



03-CFYM-T4



02-CFYM-T4



01-CFYM-T4



00-CFYM-T4



04-CFYM-T4

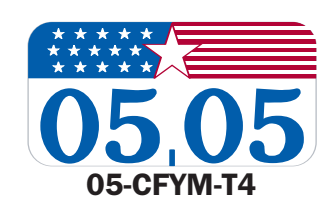

05-CFYM-T4

Future Year Colors To Be Announced

COYM SERIES
COLWELL MATCH
 3/4"H X 1-1/2"W
 Laminated 500/Roll



03-COYM-T4



04-COYM-T4



05-COYM-T4



06-COYM-T4



07-COYM-T4

CLYM SERIES
COL'R'TAB MATCH
 3/4"H X 1-1/2"W
 Laminated 1000/Roll



04-CLYM-CT5



03-CLYM-CT5



02-CLYM-CT5

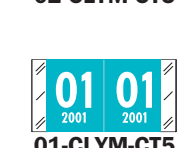

01-CLYM-CT5



05-CLYM-CT5

Clear Skirt



06-CLYM-CT5

Clear Skirt



07-CLYM-CT5

Clear Skirt

CTYM SERIES
COL'R'TAB MATCH
 3/4"H X 1-1/2"W
 Laminated 500/Roll



04-CTYM-T4



03-CTYM-T4



02-CTYM-T4



01-CTYM-T4



05-CTYM-T4

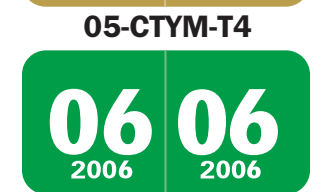

06-CTYM-T4



07-CTYM-T4

CRYM SERIES
COL'R'TAB MATCH
 3/4"H X 1-1/2"W
 Laminated 500/Roll

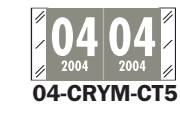

04-CRYM-CT5



03-CRYM-CT5



02-CRYM-CT5



01-CRYM-CT5



05-CRYM-CT5

Clear Skirt



06-CRYM-CT5

Clear Skirt



07-CRYM-CT5

Clear Skirt

FGYM SERIES

PMA FLUORESCENT MATCH

3/4"H X 1-1/2"W

Laminated 500/Roll



FOYM SERIES

PMA FLUORESCENT MATCH

3/4"H X 1-1/2"W

Laminated 500/Roll



FRYM SERIES

PMA FLUORESCENT MATCH

3/4"H X 1-1/2"W

Laminated 500/Roll

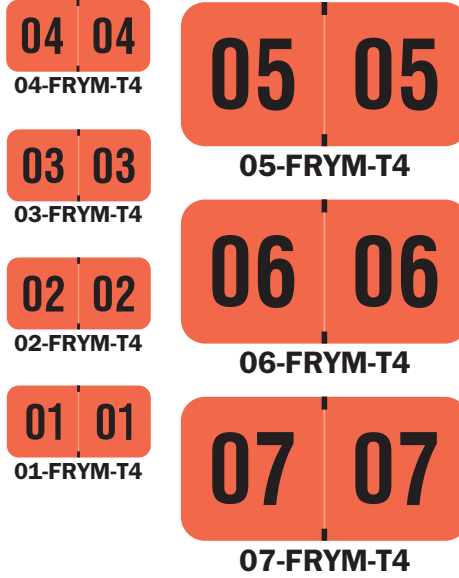

JTYM SERIES

JETER MATCH

3/4"H X 1-1/2"W

Laminated 500/Roll

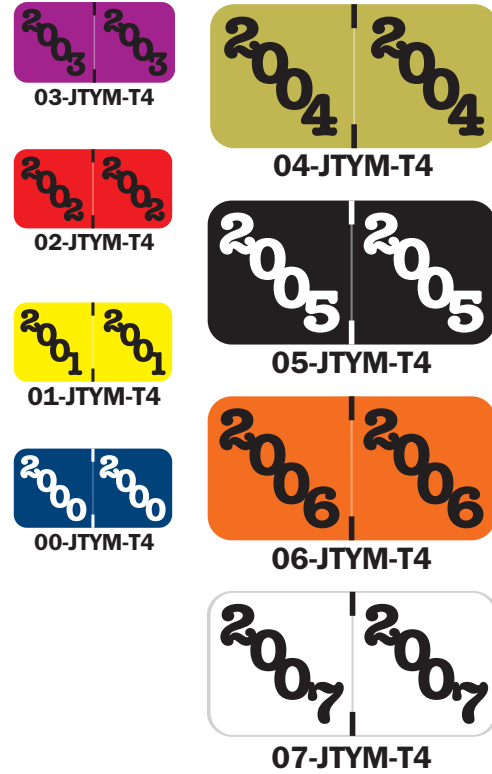

JPYM SERIES

JETER MATCH

3/4"H X 1-1/2"W

Laminated 500/Roll

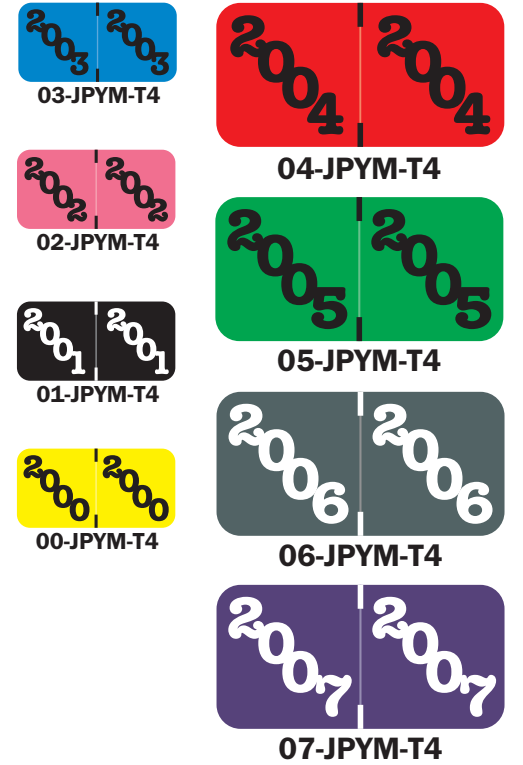

FPYM SERIES

PMA FLUORESCENT MATCH

3/4"H X 1-1/2"W

Laminated 500/Roll



FYYM SERIES

PMA FLUORESCENT MATCH

3/4"H X 1-1/2"W

Laminated 500/Roll



GBAY SERIES

PATRIOT SERIES

3/4"H X 1-1/2"W

Laminated 500/Roll



JTY3 SERIES

JETER MATCH

3/4"H X 1-1/2"W

Laminated 405/Pack

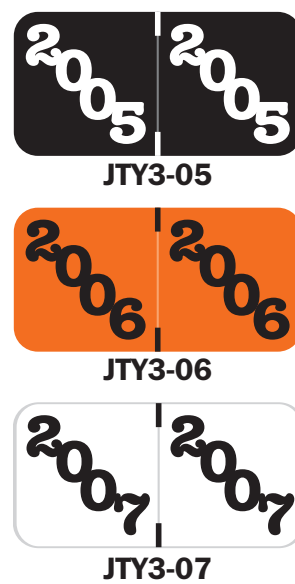

JPY3 SERIES

JETER MATCH

3/4"H X 1-1/2"W

Laminated 405/Pack

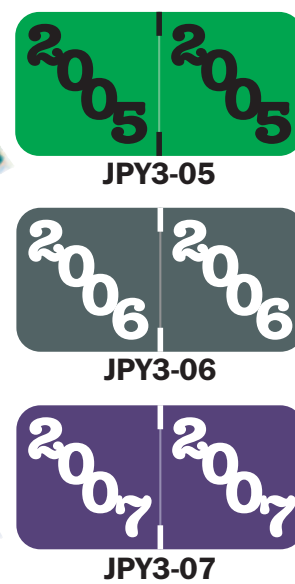

SJYM SERIES

SMEAD ETYJ MATCH

3/4"H X 1-1/2"W

Laminated 500/Roll

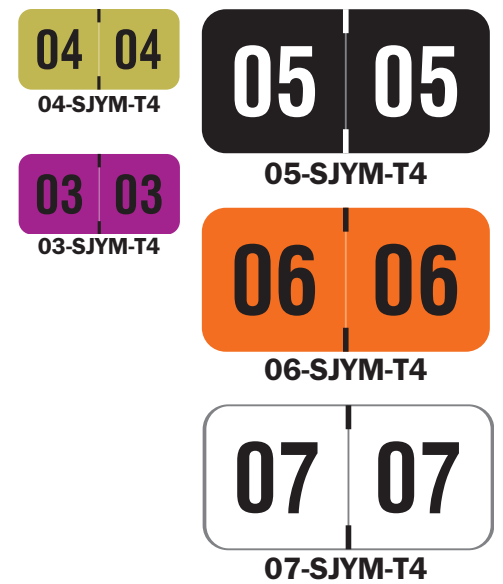

MAYM SERIES

MEDICAL ARTS PRESS MATCH

3/4"H X 1-1/2"W
Laminated 500/Roll





 *03-MAYM-T4	
 *02-MAYM-T4	*04-MAYM-T4
 *01-MAYM-T4	
	*05-MAYM-T4

* Fluorescent Ink Color

AL8800 SERIES

DATAFILE MATCH





15/16"H X 1-1/4"W
Laminated 500/Roll

04-AL8800-T3

05-AL8800-T3

06-AL8800-T3

07-AL8800-T3

PBYV SERIES

POS MATCH





3/4"H X 1-1/2"W
Vinyl 500/Roll

 03-PBYV-T4	
 02-PBYV-T4	04-PBYV-T4
	
	05-PBYV-T4

POYM SERIES

POS MATCH

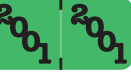



3/4"H X 1-1/2"W
Laminated 500/Roll

 03-POYM-T4	
 02-POYM-T4	04-POYM-T4
 01-POYM-T4	
	05-POYM-T4

PRYM SERIES

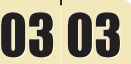
POS MATCH





3/4"H X 1-1/2"W
Laminated 500/Roll

 03-PRYM-T4	
 02-PRYM-T4	04-PRYM-T4
	
	05-PRYM-T4

RRYM SERIES

REYNOLDS & REYNOLDS MATCH

3/4"H X 1-1/2"W
Laminated 500/Roll

 03-RRYM-T4	
 02-RRYM-T4	04-RRYM-T4
	
	05-RRYM-T4

SGYM SERIES

SAFEGUARD MATCH

3/4"H X 1-1/2"W
Laminated 500/Roll

 03-SGYM-T4	
 02-SGYM-T4	04-SGYM-T4
 01-SGYM-T4	
 00-SGYM-T4	*05-SGYM-T4
	
	06-SGYM-T4
	
	07-SGYM-T4

* Fluorescent Ink Color

STYM SERIES

SAV-TYME MATCH



3/4"H X 1-1/2"W
Laminated 500/Roll

 03-STYM-T4	
 02-STYM-T4	04-STYM-T4
 01-STYM-T4	
 00-STYM-T4	*05-STYM-T4
	
	06-STYM-T4
	
	07-STYM-T4

TAYM SERIES

TABBIES MATCH

3/4"H X 1-1/2"W
Laminated 500/Roll

 04-TAYM-T4	
 03-TAYM-T4	05-TAYM-T4
 02-TAYM-T4	
 01-TAYM-T4	*06-TAYM-T4
 00-TAYM-T4	
	07-TAYM-T4



04-SLYM-L5



05-SLYM-L5

SLYM SERIES
SMEAD MATCH
 2"H X 1-1/2"W
 Laminated 500/Roll

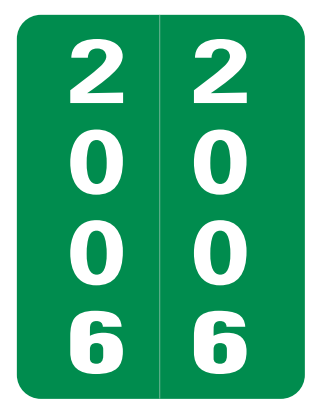

06-SLYM-L5

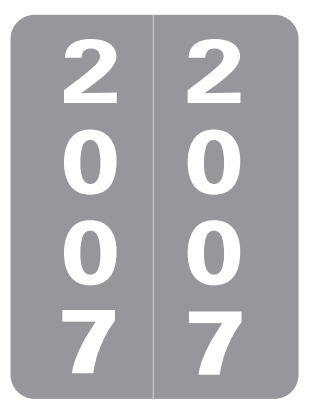

07-SLYM-L5

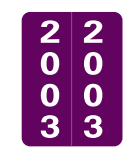

03-SLYM-L5

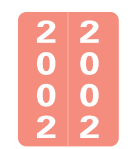

02-SLYM-L5

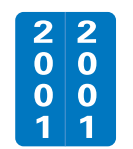

01-SLYM-L5

TTYM SERIES
SMEAD MATCH
 1"H X 1/2"W
 Laminated 500/Roll



04-TTYM-S4



05-TTYM-S4



06-TTYM-S4



07-TTYM-S4

SMYM SERIES
SMEAD MATCH
 1/2"H X 1"W
 Laminated 500/Roll



03-SMYM-S4



02-SMYM-S4



01-SMYM-S4



00-SMYM-S4



04-SMYM-S4



05-SMYM-S4



06-SMYM-S4

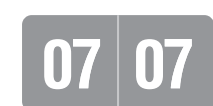

07-SMYM-S4

SYPK SERIES
SMEAD ETS MATCH
 1/2"H X 1"W
 Laminated 250/PK



04-SYPK



05-SYPK



06-SYPK

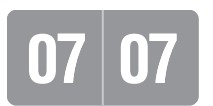

07-SYPK



TRYM SERIES
TRACO MATCH
 3/4"H X 1-1/2"W
 Laminated 500/Roll



03-TRYM-T4



02-TRYM-T4



01-TRYM-T4



04-TRYM-T4



05-TRYM-T4

Future Year
 Colors To Be
 Announced

TPYV - OLD TAB COLORS
TAB PRODUCTS MATCH
 1/2"H X 1-1/8"W
 Vinyl 500/Roll



03-TPYV-S4



03-TPYV-S4



*02-TPYV-S4



01-TPYV-S4



00-TPYV-S4



*04-TPYV-S4



05-TPYV-S4



06-TPYV-S4



07-TPYV-S4

A1287 SERIES
TAB 1287 MATCH
 1/2"H X 1-1/8"W
 Vinyl 500/Roll



03-A1287-T3



03-A1287-gy-T3



02-A1287-T3



01-A1287-T3



00-A1287-T3



04-A1287-T3



05-A1287-T3



06-A1287-T3



07-A1287-T3

A1308 SERIES
TAB 1308 MATCH
 1-1/8"H X 1/2"W
 Vinyl 500/Roll



04-A1308-T3



05-A1308-T3



06-A1308-T3



07-A1308-T3

A1309 SERIES
TAB 1309 MATCH
 1"H X 1-1/4"W
 Vinyl 500/Roll



05-A1309-T3



06-A1309-T3



07-A1309-T3



04-A1309-T3



03-A1309-gy-T3



03-A1309-T3



02-A1309-T3



01-A1309-T3



00-A1309-T3

PFYV SERIES
PROFILE MATCH
 3/4"H X 1-1/2"W
 Vinyl 500/Roll



05-PFYV-T4



06-PFYV-T4



07-PFYV-T4



*04-PFYV-T4



03-PFYV-T4

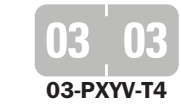

03-PXYV-T4



*02-PFYV-T4



01-PFYV-T4



00-PFYV-T4

*Fluorescent Ink Color

*Fluorescent Ink Color

MYLAR PROTECTION

NAME LABEL FOLDER PROTECTORS

MTLP - MULTI-TAPE

1-3/4"W x 80' FT Roll

Clear mylar tape comes on a handy roll for immediate use in any situation. Perforated every 2 inches, the tape can be used to keep documents from tearing out of charts, protect labels, repair torn or frayed file folders, or reinforce folder spines. Perforates easily when backing is still on, but won't tear after the backing is removed.



NAME LABEL FOLDER PROTECTORS

ADLP

1-3/4"W x 3-1/2"H 500/Box

Clear, premium polyester mylar, wrap around, self-adhesive protectors. Apply over existing labels to protect from dirt, smudges, peeling and cracking. Just remove backing sheet, fold around tab and press in place. Lay-flat liner prevents strips from curling for faster application.



NAME LABEL FOLDER PROTECTORS

AD24

2"W X 4"H 500/Pack - Shrink Wrapped

Extend the life of file folders. Clear, premium polyester mylar, self-adhesive protectors wrap around folder end tabs preventing labels from cracking or popping off. Protects folder from wear and tear. Lay-flat liner prevents curling for faster application.



FILE FOLDER END TAB PROTECTORS

AD28

2"W X 8"H 500/Pack - Shrink Wrapped

Extend the life of file folders. Clear, premium polyester mylar, self-adhesive protectors wrap around folder end tabs preventing labels from cracking or popping off. Protects folder from wear and tear. Lay-flat liner prevents curling effect for faster application.



MYLAR PROTECTION

FILE FOLDER / X-RAY EDGE PROTECTORS

AD29

2"W x 9"H 500/Pack - Shrink Wrapped

Protect the folder spine and x-ray jacket edge from fraying, cracking, and splitting due to heavy use. Clear, premium polyester mylar, self-adhesive protectors insure longer folder life. Lay-flat liner prevents curling effect for faster application.



FILE FOLDER / X-RAY EDGE PROTECTORS

AD211

2"W x 11"H 500/Pack - Shrink Wrapped

Protect the folder spine and x-ray jacket edge from fraying, cracking, and splitting due to heavy use. Clear, premium polyester mylar, self-adhesive protectors insure longer folder life. Lay-flat liner prevents curling effect for faster application.



FILE FOLDER / X-RAY EDGE PROTECTORS

AD311

3"W x 11"H 500/Pack - Shrink Wrapped

Protect the folder spine and x-ray jacket edge from fraying, cracking, and splitting due to heavy use. Clear, premium polyester mylar, self-adhesive protectors insure longer folder life. Lay-flat liner prevents curling effect for faster application.

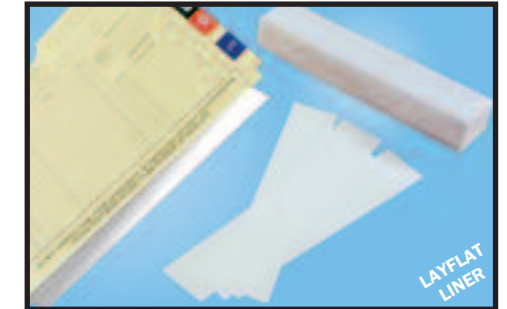

X-RAY JACKET PROTECTORS

AD317

3"W x 17"H 250/Pack - Shrink Wrapped

Prevent the bottom of x-ray jackets from tearing and splitting with clear, premium polyester mylar, self-adhesive protectors. Reinforce where the most wear and tear occurs. Lay-flat liner prevents curling effect for faster application.



TRAYS / LABEL BOXES

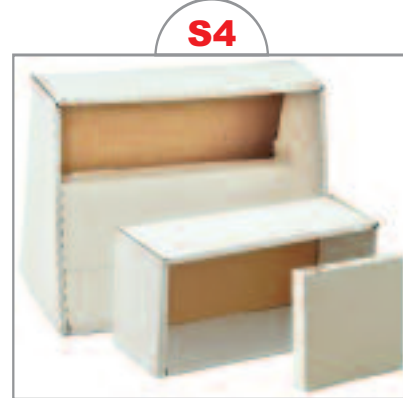

LABEL BOXES		
STOCK #	DESCRIPTION	SIZE
BOX-B45	BARKLEY BOX	4-1/2" x 1-1/4" x 4-1/2"
BOX-B45R	BARKLEY BOX REVERSE	4-1/2" x 1-1/4" x 4-1/2"
BOX-CT5	TABBIES BOX	5-3/8" x 1-11/16" x 5-3/8"
BOX-L5	LARGE BOX	5" x 2-1/8" x 5"
BOX-L5R	LARGE BOX REVERSE	5" x 2-1/8" x 5"
BOX-S4	SMALL BOX	4" x 3/4" x 4"
BOX-T3	NEW TAB BOX	3" x 1-7/16" x 3"
BOX-T4	JETER / TAB BOX	4" x 1-3/16" x 4"
BOX-V3	GBS BOX	1/2" x 1-3/4" x 3-5/8"

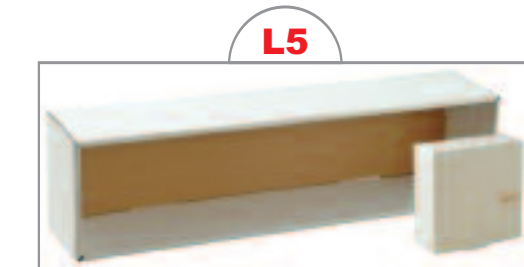
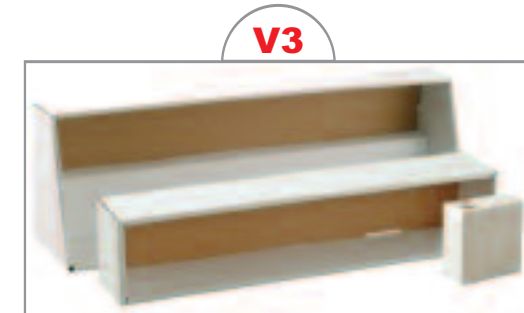

SET TRAYS		
STOCK #	DESCRIPTION	SIZE
TRAY-TAS4	S4 ALPHABETIC	8-3/4"H x 11-5/8"W
TRAY-TAV3	V3 ALPHABETIC	7-3/4"H x 25-3/4"L
TRAY-TAB45	B45 ALPHABETIC	9-3/4"H x 18-11/16"W
TRAY-TACT5	CT5 ALPHABETIC	17-3/8"H x 18-9/16"W
TRAY-TAT4	T4 ALPHABETIC	8-3/4"H x 18"W
TRAY-TAT3	T3 ALPHABETIC	9-3/4"H x 22"W
TRAY-TNT4	T4 NUMERIC	3-5/8"H x 12-3/4"W
TRAY-TNB45	B45 NUMERIC	4"H x 13-11/16"W
TRAY-TNCT5	CT5 NUMERIC	1-15/16"H x 18-5/16"W
TRAY-TNL5	L5 NUMERIC	4-1/2"H x 22-5/16"W
TRAY-TNS4	S4 NUMERIC	3-1/2"H x 9"W
TRAY-TNT3	T3 NUMERIC	4"H x 18-11/16"W
TRAY-TNV3	V3 NUMERIC	4"H x 18-11/16"W

FILM • DATE LABELS

Faster

More Efficient

Cost Effective

- Film Date Labels are the easiest way to accurately date all of your film
- Films stay organized in jacket
- Bright colors stand out
- See film dates at a glance
- Sort film without pulling from master jackets
- Pull only the films you need
- Latex-free adhesive sticks & stays stuck to the film

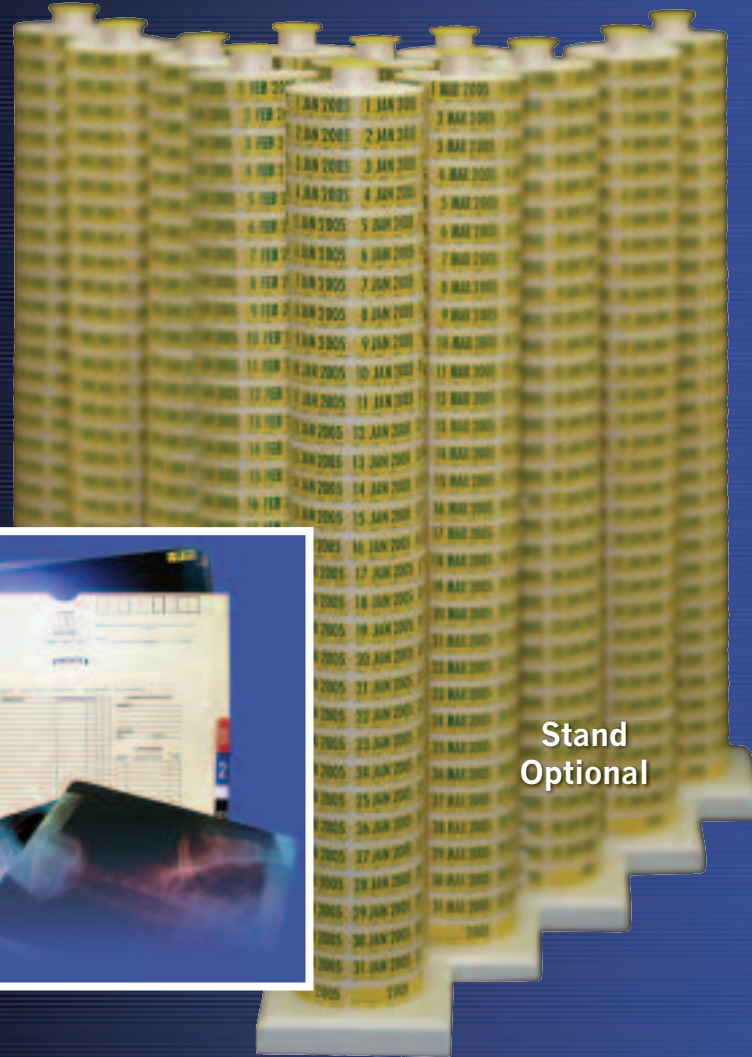

Stand
Optional

Annual Sets 365 Total Rolls



Stock #	Films per Day	Bonus Labels
SD050-YR*	50 Labels/Day	950 Labels
SD100-YR*	100 Labels/Day	1900 Labels
SD200-YR*	200 Labels/Day	3800 Labels
SD300-YR*	300 Labels/Day	5700 Labels
SD400-YR*	400 Labels/Day	7600 Labels
SD500-YR*	500 Labels/Day	9500 Labels
SDSTD	Roll Stand	



FREE! 
BONUS LABELS

* Please insert current year when ordering

